

HIOKI

Instruction Manual

IR4051

IR4052

IR4053

INSULATION TESTER

HIOKI E. E. CORPORATION

April 2015 Revised edition 3 IR4051A981-03 15-04H



* 6 0 0 3 8 7 6 9 3 *

Contents

Introduction	1
Verifying Package Contents.....	1
Options.....	3
Safety Information.....	5
Operating Precautions	9
Chapter 1 Overview	13
1.1 Product Overview	13
1.2 Features	13
1.3 Names and Functions of Parts	15
1.4 Using a Carrying Case	20
Chapter 2 Measurement Procedures	21
2.1 Measurement Preparations	21
2.2 Pre-measurement inspection	22
2.3 Inspecting the Instrument When Using the L9788-10 Test Lead with Remote Switch (Red)	23
2.4 Configuring the Comparator	24
2.4.1 Setting the Comparator	25
2.4.2 Canceling the Comparator	25
2.5 Insulation Resistance Measurement	27
IR4051A981-03 2.5.1 Lock Function.....	28

ii **Contents**

2.5.2	Measuring Insulation Resistance ...	30
2.5.3	Switching the Number of Display Digits	32
2.5.4	Displaying 1-min. Values	34
2.5.5	Voltage Characteristic of Measuring Terminals	35
2.6	Discharging Function	36
2.7	Voltage Measurement	37
2.7.1	Negative Voltage Detection	39
2.8	Low Resistance Measurement	40
2.9	PV Ω Measurement	42
2.10	Auto power save (power-saving function) .	50
2.11	Auto-backlight-off	50

Chapter 3 Specifications 51

Chapter 4 Maintenance and Service 61

4.1	Troubleshooting	61
4.2	Replacing Batteries or Fuse	66
4.3	Replacing the Pin (Option)	68
4.4	Cleaning	68

Appendix A1

Introduction

Thank you for purchasing the HIOKI Model IR4051, IR4052, IR4053 Insulation Tester. To obtain maximum performance from the instrument, please read this manual first, and keep it handy for future reference.







The “instrument” in this manual means IR4051, IR4052, or IR4053.

Verifying Package Contents

- When you receive the instrument, inspect it carefully to ensure that no damage occurred during shipping. If damage is evident, or if it fails to operate according to the specifications, contact your authorized Hioki distributor or reseller.
- When transporting the instrument, use the original packing materials in which it was shipped, and pack in a double carton. Damage occurring during transportation is not covered by warranty.

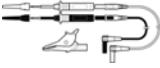
2 Verifying Package Contents







Package Contents

Model	Name	
	Version	
Accessories	Insulation Tester x1	
	IR4051, IR4053	
		
	IR4052	
		
	-10	-11
	L9787 Test Lead* x1	L9788-11 Test Lead Set with Remote Switch* x1
		
C0100 Carrying Case x1 (Included with the IR4052.)		
Instruction manual x1		
Neck strap (Included with the IR4051 and IR4053.) x1		
LR6 alkaline battery x4		

* L9787 Test Lead and L9788-11 Test Lead Set with Remote Switch are all exclusively designed for the HIOKI IR4000 series. Do not use for any other purpose.

Options

The following options are available for the IR4000 series. Ask your authorized Hioki distributor or reseller when ordering.

	<input type="checkbox"/> L9787 Test Lead * (1.2 m)
	<input type="checkbox"/> L9787-91 Breaker Pin (Pin length 70 mm and 48 mm from the tip has width 2.5 mm. The rest have width 3.8 mm.) Breaker pin for model L9787.
	<input type="checkbox"/> L9788-10 Test Lead with Remote Switch (Red) * (1.2 m) Test lead with MEASURE key for the line side measurement. Measurement can be started by pressing the key. There is a light at the tip which can be switched on by pressing the LIGHT key on the IR4000 Series. Earth side lead is not attached.
	<input type="checkbox"/> L9788-11 Test Lead Set with Remote Switch * Set of the model L9788-10 and L9787 with an EARTH side lead.
	<input type="checkbox"/> L9788-90 Tip Pin Replacement Tip Pin for model L9788-10.
	<input type="checkbox"/> L9788-92 Breaker Pin (Pin length 123 mm and 65 mm from the tip has width 2.6 mm.) Breaker pin for model L9788-10.
	<input type="checkbox"/> 9804-02 Magnetic Adapter (Ø11 mm Corresponding standard screw: M6 Button head screw) Adaptor for connecting a Test lead to the round head screw by means of magnetism. The tip of adaptor is a concave shape in order to fit the round head screw. Put an adaptor on the tip of the earth side lead of a L9787 Test Lead or L9788-01 Complete Test Lead.

4 Options



C0100 Carrying Case
Carrying case for the IR4052.

* L9787 Test Lead, L9788-10 Test Lead with Remote Switch (Red) and L9788-11 Test Lead Set with Remote Switch are all exclusively designed for the HIOKI IR4000 series. Do not use for any other purpose.

Safety Information

This instrument is designed to conform to IEC 61010 Safety Standards, and has been thoroughly tested for safety prior to shipment. However, using the instrument in a way not described in this manual may negate the provided safety features.

Before using the instrument, be certain to carefully read the following safety notes.

DANGER

Mishandling during use could result in injury or death, as well as damage to the instrument. Be certain that you understand the instructions and precautions in the manual before use.

WARNING



- With regard to the electricity supply, there are risks of electric shock, heat generation, fire, and arc discharge due to short circuits. If persons unfamiliar with electricity measuring instrument are to use the instrument, another person familiar with such instruments must supervise operations.
 - **Protective gear**
This instrument is measured on a live line. To avoid electric shock when measuring live lines, wear appropriate protective gear, such as insulated rubber gloves, boots and a safety helmet.
-

Safety Symbols

This manual contains information and warnings essential for safe operation of the instrument and for maintaining it in safe operating condition. Before using it, be sure to carefully read the following safety precautions.



In the manual, the  symbol indicates particularly important information that the user should read before using the instrument.

The  symbol printed on the instrument indicates that the user should refer to a corresponding topic in the manual (marked with the  symbol) before using the relevant function.



Indicates that dangerous voltage may be present at this terminal.



Indicates a double-insulated device.



Indicates a grounding terminal.



Indicates DC (Direct Current).



Indicates AC (Alternating Current).

The following symbols in this manual indicate the relative importance of cautions and warnings.



Indicates that incorrect operation presents an extreme hazard that could result in serious injury or death to the user.



Indicates that incorrect operation presents a significant hazard that could result in serious injury or death to the user.



Indicates that incorrect operation presents a possibility of injury to the user or damage to the instrument.



Indicates advisory items related to performance or correct operation of the instrument.

Accuracy

We define measurement tolerances in terms of rdg. (reading) and dgt. (digit) values, with the following meanings:

rdg. (reading or displayed value)

The value currently being measured and indicated on the measuring instrument.

rdg. (reading or displayed value)

The smallest displayable unit on a digital measuring instrument, i.e., the input value that causes the digital display to show a "1" as the least-significant digit.

Measurement categories

This instrument complies with CAT III safety requirements. To ensure safe operation of measurement instruments, IEC 61010 establishes safety standards for various electrical environments, categorized as CAT II to CAT IV, and called measurement categories.

CAT II:	Primary electrical circuits in equipment connected to an AC electrical outlet by a power cord (portable tools, household appliances, etc.) CAT II covers directly measuring electrical outlet receptacles.
CAT III:	Primary electrical circuits of heavy equipment (fixed installations) connected directly to the distribution panel, and feeders from the distribution panel to outlets.
CAT IV:	The circuit from the service drop to the service entrance, and to the power meter and primary overcurrent protection device (distribution panel).

Using a measurement instrument in an environment designated with a higher-numbered category than that for which the instrument is rated could result in a severe accident, and must be carefully avoided.

Use of a measurement instrument that is not CAT-rated in CAT II to CAT IV measurement applications could result in a severe accident, and must be carefully avoided.

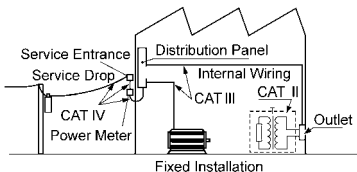

Operating Precautions



Follow these precautions to ensure safe operation and to obtain the full benefits of the various functions.

Preliminary Checks

Before using the instrument for the first time, verify that it operates normally to ensure that no damage occurred during storage or shipping. If you find any damage, contact your authorized Hioki distributor or reseller.

⚠ WARNING

To prevent an electric shock accident, confirm that the white or red portion (insulation layer) inside the cable is not exposed. If a color inside the cable is exposed, do not use the cable.

Setting up the Instrument

Operating temperature and humidity (p.52)

Accuracy guarantee for temperature and humidity (p.54)

Avoid the following locations that could cause an accident or damage to the instrument.



Exposed to direct sunlight
Exposed to high temperature



In the presence of corrosive or explosive gases



Exposed to water, oil, other chemicals, or solvents
Exposed to high humidity or condensation



Exposed to strong electromagnetic fields
Near electromagnetic radiators



Exposed to high levels of particulate dust



Near induction heating systems (e.g., high-frequency induction heating systems and IH cooking utensils)



Subject to vibration

⚠ DANGER

- The maximum rated voltage between input terminals and ground is 600 V DC/AC (CAT III). Attempting to measure voltages exceeding 600 V DC/AC with respect to ground could damage the instrument and result in personal injury.
 - 1000 V or 600 V may be labeled depending on the supplied test leads, but this is the rating of the test lead and not the rating performance of this instrument. Please refer to the Specifications for the rating performance of this instrument.
 - Before attaching to or removing the test lead from the instrument, please remove the Test Lead from the tested object and turn the rotary selector to OFF.
 - Test leads should only be connected to the secondary side of a breaker, so the breaker can prevent an accident if a short circuit occurs. Connections should never be made to the primary side of a breaker, because unrestricted current flow could cause a serious accident if a short circuit occurs.
-

 **WARNING**

- Please only use batteries for electrical supply. Any other electrical supply may damage the instrument and tested object and cause electric shock.
 - Persons wearing electronic medical devices such as a pacemaker should not use the 9804-02 Magnetic Adapter with magnet (option). Such persons should avoid even proximity to the 9804-02, as it may be dangerous. Medical device operation could be compromised, presenting a hazard to human life.
 - Do not bring the 9804-02 near magnetic media such as floppy disks, magnetic cards, pre-paid cards, or magnetized tickets. Doing so may corrupt and may render them unusable. Furthermore, if the 9804-02 is brought near precision electronic equipment such as computers, TV screens, or electronic wrist watches, they may fail.
-

CAUTION

- This instrument is designed for use indoors. It can be operated at temperatures between 0 and 50°C without degrading safety.
- For safety reasons, when taking measurements, only use the L9787, L9788-11 or optional test lead provided with the instrument.
- To avoid breaking the test lead, do not bend or pull them.
- To avoid damage to the instrument, protect it from physical shock when transporting and handling. Be especially careful to avoid physical shock from dropping.
- Do not bring the tips of test leads into contact with the control terminal that is used to connect a test lead with a remote control switch. Doing so may damage the instrument.
- Do not slant the instrument or place it on top of an uneven surface. Dropping or knocking down the device can cause injury or damage to the instrument.
- If the protective functions of the instrument are damaged, either remove it from service or mark it clearly so that others do not use it inadvertently.
- To avoid damaging the cables, unplug it by grasping the connector, not the cable.
- Although this instrument is dust resistant, it is not completely dust- or waterproof. To prevent possible damage, avoid using in dusty or wet environments.
- The protection rating for the enclosure of this device (based on EN60529) is *IP40.

*IP40:

This indicates the degree of protection provided by the enclosure of the device against use in hazardous locations, entry of solid foreign objects, and the ingress of water.

- 4: Protected against access to hazardous parts with wire measuring 1.0 mm in diameter. The equipment inside the enclosure is protected against entry by solid foreign objects larger than 1.0 mm in diameter.
- 0: The equipment inside the enclosure is not protected against the harmful effects of water.

NOTE

The battery indicator flashes when the remaining battery capacity is low. In this case, measurement is not possible. Replace the batteries. (p.66)

Overview

Chapter 1

1.1 Product Overview

This instrument is an insulation ohmmeter that shortens work times associated with insulation testing. It is not designed for use on manufacturing lines and should not be used in such applications. For manufacturing line applications, use the ST5520 Insulation Tester.

1.2 Features

◆ High-speed response

Since the instrument delivers dramatically improved response speeds compared to previous models, it can be used as a pointer-type device.

◆ Enhanced comparator function

Since the process from the start of measurement to a PASS/FAIL judgment is extremely fast, the instrument is suitable for tester continuity check use. The display will turn red when a FAIL judgment results.

◆ Low variation in measured values

The instrument generates little variation in measured values when used in a typical measuring environment.

◆ Easy-to-view display

The instrument uses an LCD with a wide viewing angle and a backlight driven by a high-brightness white LED.

◆ High-accuracy voltage measurement function

Since the instrument incorporates a DC/AC voltmeter with the same accuracy as a card tester, there is no need to switch to a card tester when you need to measure voltage.

◆ User-selectable number of display digits **IR4052**

The instrument's number of display digits can be changed.

◆ PV Ω measurement function **IR4053**

The PV Ω measurement allows accurate insulation resistance measurements of a solar panel.

1.3 Names and Functions of Parts

Front Panel

IR4051 **IR4052**

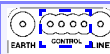

Terminals (on top)
Terminals for controlling
Model L9788-10.

*This figure is model IR4052.

⚠ "2. Measurement Procedures"

Display

⚠ (p.23)

⚠ (p.23)

Measure key
Press to measure insulation resistance.

EARTH terminal
Connect the black test lead.

LINE terminal
Connect the red test lead.

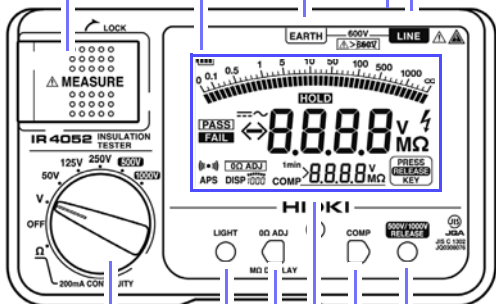

Rotary selector
Select measurement functions.

LIGHT key
Press this key to turn on and off the light.

0Ω ADJ/ MΩ DISPLAY key

- Press this key to perform zero-adjustment for the low resistance range.
- Press this key to change the number of display digits for the insulation resistance range.

IR4052

RELEASE key
Press this key before measurement to set the instrument to the 500 V or 1000 V range (to prevent erroneous application of the test signal).

COMP key
Press this key to set the comparator's judgment reference value.

Live circuit indicator
Lights up when voltage remains between input terminals



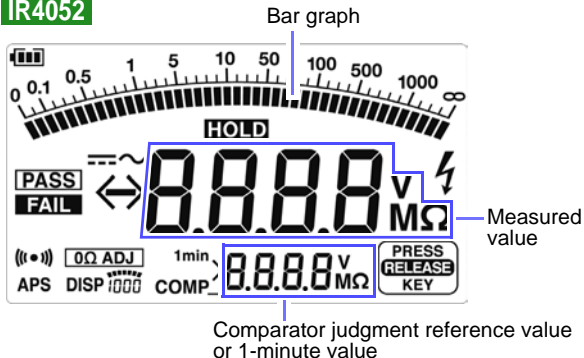

16 1.3 Names and Functions of Parts

Display

IR4052



	Indicates the remaining battery life as one of three levels. The battery mark outline will flash when the remaining battery life reaches 0, at which point the instrument will no longer perform measurement.
	Turns on when the voltage measured with the V range is DC.
	Turns on when the voltage measured with the V range is AC.
	Flashes when the measured value is less than the minimum display value.
	Flashes when the measured value is greater than the maximum display value.
HOLD	Lights up when the measured value is held.
PASS	Turns on when the comparator judgment is PASS (good). See: "2.4.1 Setting the Comparator" (p.25)
FAIL	Turns on when the comparator judgment is FAIL (defective). See: "2.4.1 Setting the Comparator" (p.25)
	Flashes when a dangerous voltage exists between the measurement terminals.

	When the comparator is enabled, the buzzer will sound when the judgment result (PASS or FAIL) for which this mark is lit up is encountered.
APS	The auto power save function will activate 30 seconds after this mark starts flashing. See: "2.10 Auto power save (power-saving function)" (p.50)
	Lights up when zero adjustment is made during low resistance measurement. See: "2.8 Low Resistance Measurement" (p.40)
DISP 	Indicates the number of display digits. See: "2.5.3 Switching the Number of Display Digits" (p.32)
1min	Turns on when 1 minute has passed since the start of insulation resistance measurement. Indicates that the resistance value on the bottom of the display is a 1-minute value (the measured value 1 minute after the start of measurement). See: "2.5.4 Displaying 1-min. Values" (p.34)
COMP	Lights up when the comparator function is enabled. See: "2.4 Configuring the Comparator" (p.24)
	Turns on when the instrument is set to the 500 V range or the 1000 V range. Pressing  turns off the indicator and enables insulation measurement.

Display **IR4051**

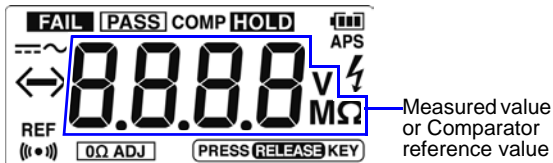

REF	Lights up when the criterion for the comparator function is indicated.
------------	--

For more information about other display elements, see **IR4052** (p.16).

Front Panel **IR4053**

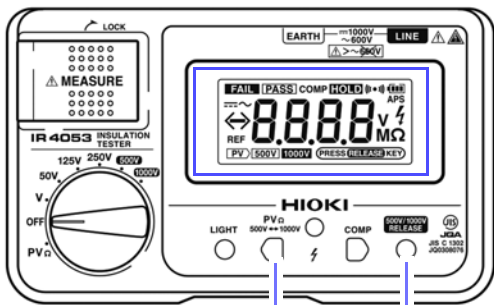

500V ↔ 1000V key
 PVΩ range is used to switch between 500V and 1000V.

RELEASE key

- Press this key before measurement after any of 500 V or 1000 V ranges is used (to prevent from misuse).
- When PVΩ range is set, the voltage to be applied will be determined.

Other functions are same with the ones for IR4051 and IR4052.

Display **IR4053**



A measured value or a comparator reference

PV	Lit when PVΩ measurement mode is selected.
500V	Lit when 500 V range is selected in PVΩ measurement mode.
1000V	Lit when 1000V range is selected in PVΩ measurement mode.

See display of **IR4052** (p.16) for other indications.

L9788-10 Test Lead with Remote Switch (Red)

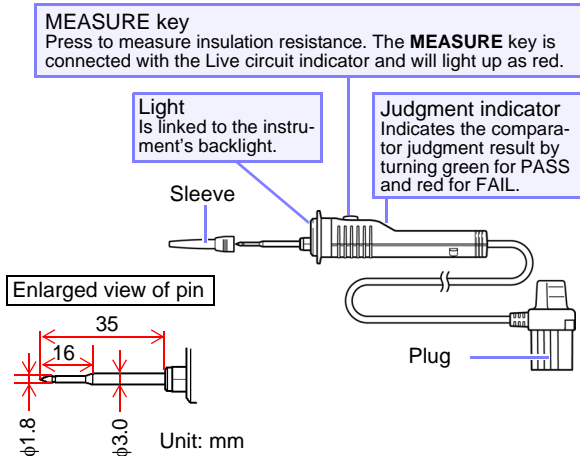

CAUTION

The Insulation Resistance Tester's **MEASURE** key will still be available even when this test lead is connected to the Insulation Resistance Tester. When connected to the Insulation Resistance Tester, take note that a test voltage will be discharged even when the **MEASURE** key of the Tester is pressed.

L9788-92 Breaker Pin Connection

First take out the sleeve from the L9788-10, and then install the Breaker pin (L9788-92).



Plug it all the way to the end.

1.4 Using a Carrying Case **IR4052**

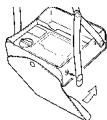

Undo the snap fastener on OPEN mark side. Lift the cover and pivot it to the side and under the case itself and redo the snap fastener on the side of the cover.

Fasten the strap as shown below. You can use the instrument hanging around your neck.

-
1. Undo the snap fastener for the strap on the left side of the case.
 2. Undo the snap fastener for the strap on the right side of the case and redo it as shown in the right figure

Carrying case inside structure **IR4052**

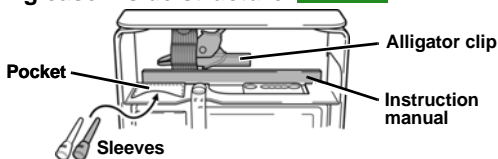

CAUTION

- Removable sleeves are attached to the metal pins at the ends of the test leads. To prevent a short circuit accident, be sure to use the test leads with the sleeves attached when performing measurements in the CAT III measurement category. Remove the sleeves from the test leads when performing measurements in the CAT II measurement category. The instrument can be used with the sleeves removed when measuring the secondary side of a circuit breaker that is off. For details on measurement categories, see "Measurement categories" (p.8) in the instruction manual.
- When performing measurements with the sleeves attached, be careful to avoid damaging the sleeves. If the sleeves are inadvertently removed during measurement, be especially careful in handling the test leads to avoid electric shock.

Measurement Procedures

Chapter 2

2.1 Measurement Preparations

1. Attach the strap.
2. Insert the batteries. (p.66)
3. Connect the test lead (connect the black test lead to the EARTH terminal, and the red test lead to the LINE terminal)

Attaching the strap

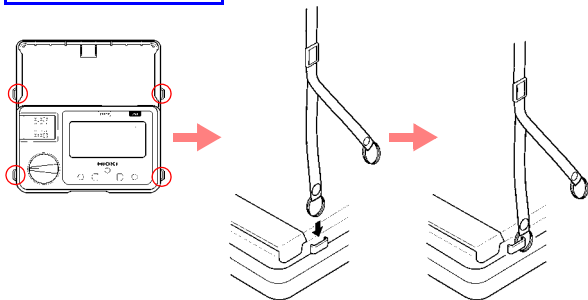
IR4051**IR4053**

Pass the ring on both ends of the supplied strap through each of the four holes in the instrument.

⚠ CAUTION

Attach the strap securely to the four fittings on the instrument. If insecurely attached, the instrument may fall and be damaged when carrying.

2.2 Pre-measurement inspection

Checking the remaining battery life

Isn't the battery exhausted?

Set the rotary selector away from OFF and confirm the battery indicator.

The battery indicator is flashing.



Replace the batteries.
See: (p.66)

There is battery life remaining.



Checking the test lead

Isn't the white portion (insulation layer) inside the cable exposed?

Exposed

Do not use if damage is present as you could receive an electric shock. Contact your authorized Hioki distributor or reseller for replacements.

No Exposed

1. Use the rotary selector to select Insulation Resistance.
2. Short the test lead tips.
3. Press the **MEASURE** key. Does the display show 0 MΩ?

No

The following issues may be occurring:

- The test lead has not been inserted all the way.
→ Insert the test lead all the way.
- There is a broken connection in the test lead.
→ Replace with the designated test lead.

Yes

Inspection complete

Please read the "Operating Precautions" (p.9) before use.

2.3 Inspecting the Instrument When Using the L9788-10 Test Lead with Remote Switch (Red)

⚠ WARNING

To prevent an electric shock accident, confirm that the white portion (insulation layer) inside the cable is not exposed. If a color inside the cable is exposed, do not use the cable.

1. Confirm that the power of the Insulation Resistance Tester is turned off.
2. Plug the test lead securely into the LINE terminal of the Insulation Resistance Tester.



3. Short circuit the tips of the test leads.
4. Use the rotary selector to select Insulation Resistance.
5. Upon pressing the **MEASURE** key on the L9788-10, verify that the L9788-10's **MEASURE** key turns red when the instrument's live wire warning is displayed and that the display shows 0 MΩ.

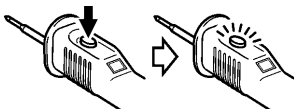

6. Press  of the instrument to confirm that the light at the tip of the L9788-10 comes on.

2.4 Configuring the Comparator

The instrument provides a comparator function that can be used with the insulation resistance, low resistance, and PV Ω ranges. Use of the comparator function simplifies the process of obtaining a PASS/FAIL judgment.

The comparator function generates PASS (good) and FAIL (defective) judgments depending on whether the measured value is greater than or less than a previous set value. The instrument notifies the user of the judgment result with the buzzer and backlight (which turns red for a FAIL judgment). Furthermore, you can view judgment results more closely at hand by using the L9788-10 Test Lead with Remote Switch (Red). (The L9788-10 incorporates an LED that turns green for PASS judgments and red for FAIL judgments.)

For more information about valid comparator settings, see “Valid judgment reference values” (p.26).

In the insulation resistance and PV Ω ranges, measured values that are greater than or equal to the judgment reference value result in a PASS judgment. The buzzer will sound in the event of a FAIL result.

In the low resistance range, measured values that are less than or equal to the judgment reference value result in a PASS judgment. The buzzer will sound in the event of a PASS result.

Comparator settings for each range will be saved, even if the instrument is turned off.

NOTE The comparator cannot be used with voltage ranges.

2.4.1 Setting the Comparator

1. Select a judgment reference from the table on p.26.
2. Set the rotary selector to the range for which you wish to set the judgment reference.



Note: In 500 V/1000 V range, press  to release the lock.

In PVΩ range, select the voltage to be applied with

 and press  to release the lock.

3. Pressing  causes “**COMP**” to flash and displays the resistance value that will be used as the judgment reference.

The IR4051 will display “REF.”  

Press  or  to select the judgment reference.

4. If you do nothing for about 2 seconds after you select the desired judgment reference, the comparator will be set, and the “**COMP**” mark will light up on the display.

2.4.2 Canceling the Comparator

Press the  several times to select “**oFF**.” If you do nothing for about 2 seconds in this state, “**COMP**” will go out, and the comparator function will be canceled.

26 2.4 Configuring the Comparator

Valid judgment reference values

Range	Reference value						Unit
50 V	0.01	0.02	0.03	0.04	0.05	-	MΩ
	0.1	0.2	0.3	0.4	0.5	-	
	1 ^{*1}	2	3	4	5	-	
	10	-	-	-	-	-	
125 V	0.1	0.2	0.3	0.4	0.5	-	
	1 ^{*1}	2	3	4	5	-	
	10	20	-	-	-	-	
250 V	0.1	0.2	0.3	0.4	0.5	-	
	1 ^{*1}	2	3	4	5	-	
	10	20	30	40	50	-	
500 V/ PVΩ500V	0.1	0.2 ^{*2}	0.3	0.4	0.5	-	
	1 ^{*1}	2	3	4	5	-	
	10	20	30	40	50	-	
	100	-	-	-	-	-	
1000 V ^{*3} / PVΩ1000V	0.1	0.2	0.3	0.4 ^{*2}	0.5	-	
	1	2	3	4	5	-	
	10 ^{*1}	20	30	40	50	-	
	100	200	300	400	500	-	
Ω	0.1	0.2	0.3	0.4	0.5	0.6	Ω
	1	2	3	4	5	6	
	10	20 ^{*1}	30	40	50	60	
	100	200	-	-	-	-	

*1: Factory initial setting

*2: Factory initial setting when PVΩ function is selected.

*3: Reference 0.1 to 0.5 is only for IR4053.

2.5 Insulation Resistance Measurement



The instrument is used to measure insulation resistance in the electric circuit or in the appliance in order to inspect the insulation performance. When measuring insulation resistance, you have to select the voltage applied to the object to be measured.

WARNING

Observe the following to avoid electric shock, short circuits and damage to the instrument:

- When measuring insulation resistance, dangerous voltage is applied to the measurement terminals. To avoid electric shock, do not touch the metal part of the test leads.
- Never touch the object being measured immediately after measuring. There is danger of electric shock from the charge accumulated during high voltage testing.
- Discharge the subject conductor after measurement. (p.36)
- Do not attempt to measure insulation resistance on a live conductor. Doing so could damage the instrument or cause an accident that might result in injury or death. Always turn off power to the conductor being measured before starting.

NOTE

- Insulation resistance is the ratio of leakage current to applied voltage, and is therefore unstable. Depending on the specific object being measured, the displayed value may not stabilize, this does not necessarily indicate a malfunction.
- Press the **MEASURE** key fully down until a live circuit indicator lights up. If the button is not pressed down fully, a proper measurement cannot be made.
- After use, please turn the rotary selector to OFF.
- When inspecting on an electric power circuit including an appliance whose withstand voltage is lower than the test voltage or including an appliance or components whose withstand voltage is unknown, it is recommendable to remove that from the circuit for measurement.

2.5.1 Lock Function

In order to prevent the inadvertent application of 500 V or 1000 V to a low-voltage device, the instrument provides a lock function. This function will prevent the test voltage from being output even if the **MEASURE** key is pressed while the rotary selector is set to the 500 V, 1000 V, or PVΩ range.

Releasing the lock

- Setting the rotary selector to the 500 V, 1000 V, or PVΩ range will cause **PRESS RELEASE KEY** (IR4052) or **PRESS RELEASE KEY** (IR4051, IR4053) to light up, and **500V/1000V RELEASE** will flash.

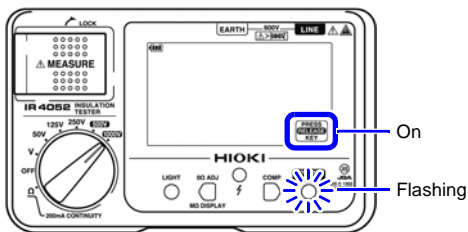

2.5 Insulation Resistance Measurement 29

2. Press to turn off or as well as , disabling the lock. The display will also change to the measurement screen.

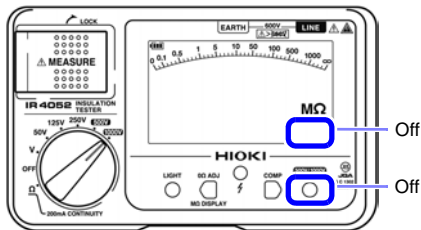

The instrument will return to the state described in Step 1. when 1 minute elapses after the last measurement or operation. Press

- to release the lock.

2.5.2 Measuring Insulation Resistance



CAUTION

Always turn off the breaker of the measurement line.

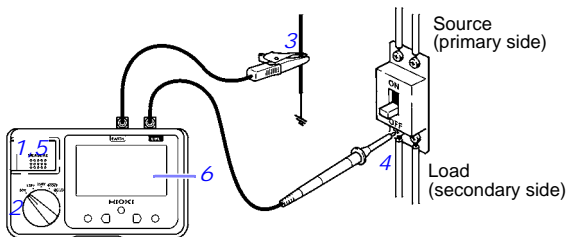

Ex. When measuring the insulation resistance between circuit and ground

1. If the **MEASURE** key is in the raised position, fold it back.
2. Set the rotary selector to a test voltage of 50 V to 1000 V. In the 500 V or 1000 V range, press  to release the lock.
3. Connect the black test lead to the ground side of the object being measured.
4. Connect the red test lead to the line to be measured.
5. Press the **MEASURE** key. (To make continuous measurements, pull the button up.)
6. Read the value after the indicator has stabilized.
7. Turn off the **MEASURE** key while the test leads are connected to the measurement object.

2.5 Insulation Resistance Measurement 31

8. The final measured value will be displayed along with **HOLD**, and discharge will start.
9. When  disappears, measurement is complete.

NOTE

- During measuring, do not selector over to the other function.
- The instrument will return to the locked state when about 1 minute of no operation elapses in the 500 V and 1000 V ranges. To continue measurement, press  again to release the lock.





2.5.3 Switching the Number of Display Digits





IR4052

The IR4052 provides functionality for switching the number of display digits.

Insulation resistance values for insulated objects are unstable by their nature. Consequently, the lower digits of displayed values may occasionally oscillate back and forth. In such a situation, work efficiency can be improved by reducing the number of display digits.

Switching the number of display digits

Press  to switch the number of display digits. Each time you press , the number of display digits will change as shown in the following table. You can see what number of digits is currently being displayed by looking at **DISP**  on the bottom of the display. When the number of display digits is in 100 count or 10 count mode, *lower digits that are not displayed are discarded*. For example, a reading of 57.9 MΩ in 1,000 count display mode would be shown as 57 MΩ in 100 count mode or 50 MΩ in 10 count mode.

Display mode no.	Number of display digits	DISP  display	Example display
1	1,000 count	DISP 	57.9 _{MΩ}
2	100 count	DISP 	57 _{MΩ}
3	10 count	DISP 	50 _{MΩ}

2.5 Insulation Resistance Measurement 33

In 10 count display mode, each range's maximum display value is reduced as shown in the following table (the display value for a pointer-type insulation ohmmeter is used). Furthermore, only values shown on the pointer-type insulation ohmmeter's graduations are shown. Select this setting when you wish to use the instrument as a pointer-type insulation ohmmeter.

NOTE When the comparator is set, values near the comparator setting will be displayed in 1,000 count display mode, regardless of the display mode setting.

Range	Maximum display value	
	1,000 count display mode 100 count display mode	10 count display mode
50 V	100 M Ω	10 M Ω
125 V	250 M Ω	20 M Ω
250 V	500 M Ω	50 M Ω
500 V	2000 M Ω	100 M Ω
1000 V	4000 M Ω	2000 M Ω

2.5.4 Displaying 1-min. Values **IR4052**

The IR4052 provides functionality for automatically holding the measured value obtained 1 minute after the start of measurement (after pressing the **MEASURE** key). The measured value that is held will be shown on the bottom of the display. No value is shown if less than 1 minute has elapsed since the start of measurement. Regardless of the selected display mode, 1-min. values are always displayed in 1,000 count display mode.

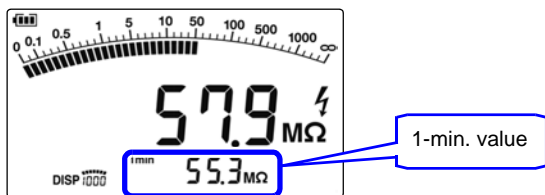

Use this function when measuring targets that include a capacitance component.

NOTE This function is enabled only when the comparator is set to “off.”

2.5.5 Voltage Characteristic of Measuring Terminals

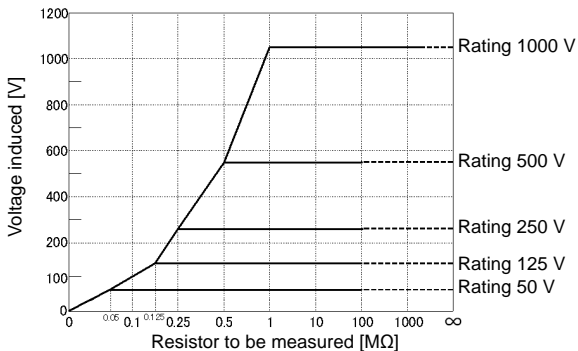

2.6 Discharging Function



When measuring an insulation resistance that contains a capacitance element, a charge proportional to the measurement voltage accumulates, and if undischarged could lead to an electric shock accident.

1. Without removing the test leads from the item being measured, release the **MEASURE** key.
2. The built-in discharge circuit automatically discharges the item.

On the IR4052, the amount of remaining bar graph will decrease when the instrument is discharged.

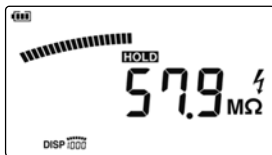

3. The discharge will end when the ⚡ disappears.

(The time required for discharge depends on the capacitance value.)



NOTE Measurement of a solar panel may fail to turn off ⚡ because the voltage generated by the solar panel is detected after completely discharged.

2.7 Voltage Measurement



This instrument can measure the AC of commercial power. It is also useful to make sure the subject conductor is not live before measuring insulation resistance.

⚠ DANGER

- Test leads should only be connected to the secondary side of a breaker, so the breaker can prevent an accident if a short circuit occurs. Connections should never be made to the primary side of a breaker, because unrestricted current flow could cause a serious accident if a short circuit occurs.
 - The maximum input voltage is 600 V DC/AC (600 V AC, 1000 V DC for IR4053). Attempting to measure voltage in excess of the maximum input could destroy the instrument and result in personal injury or death.
 - The maximum rated voltage between input terminals and ground is 600V DC/AC (CAT III). Attempting to measure voltages exceeding 600 V with respect to ground could damage the instrument and result in personal injury.
 - To avoid electrical shock, be careful to avoid shorting live lines with the test leads.
-

⚠ WARNING

Never press the **MEASURE** key while measuring voltage. Doing so could damage the circuitry or cause an accident that might result in injury or death.

38 2.7 Voltage Measurement

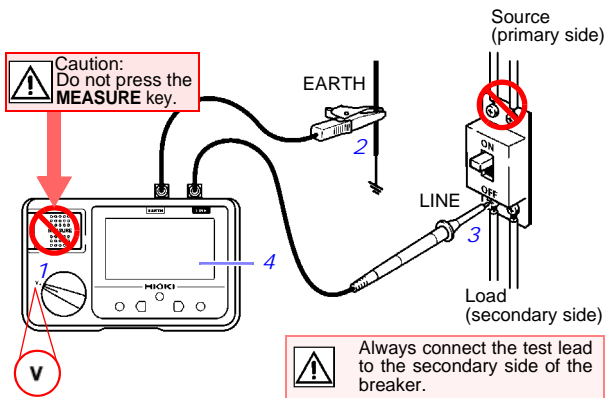

Ex. When measuring the voltage between circuit and ground

1. Use the rotary selector to select the V function.
2. Connect the black test lead to the ground side of the object being measured.
3. Connect the red test lead to the line side of the breaker.
4. Read the value after the indicator has stabilized.



NOTE

- During measuring, do not selector over to the other function.
- For waveforms other than sine waves, some errors may occur.

2.7.1 Negative Voltage Detection **IR4053**

When measured voltage is -1 V or lower, the display lights in red and white alternately. It is easy to find a reversed connection while checking open voltage of a solar cell string. The factory default is set to ON.

Setting method

1. Hold  and set the rotary switch to "V".
2. "—" and "V" blink and "ON" or "OFF" will be indicated.
3. Pressing  switches between ON and OFF.

ON: When measured voltage is -1 V or lower, the display lights in red and white alternately.

OFF: Disables this function.

When no operation is made until approximately two seconds after ON or OFF is selected, the setting chosen will be fixed and measurement screen appears.

2.8 Low Resistance Measurement

IR4051 **IR4052**

WARNING

Do not measure under a live circuit condition.

Before measurement, always perform zero adjustment to cancel the test leads' wiring resistance and other potentially problematic quantities. Accurate measurement will not be possible if zero adjustment is not performed.

1. Set the rotary selector to the Ω function.
2. Short circuit the tip of the test lead.
3. Pull up the **MEASURE** key.
4. Turn off the **MEASURE** key to hold the measured value.
5. Press .
6. Connect the test lead to the ground side of the object being measured.
7. Press the **MEASURE** key and read the displayed value.
8. Turn off the **MEASURE** key after using.

NOTE Zero adjustment can be performed with readings of up to a maximum of 3 Ω . When the reading exceeds 3 Ω , "Err 1" will be displayed, and zero adjustment will not be possible. Wire the instrument so that the wiring resistance is 3 Ω or less.

In the following circumstances, repeat the zero adjustment procedure:

- After changing test leads
- When the ambient temperature changes by 1°C or more
- After replacing the fuse

2.8 Low Resistance Measurement 41

The comparator function can be used during low resistance measurement.

See: “2.4 Configuring the Comparator” (p.24)

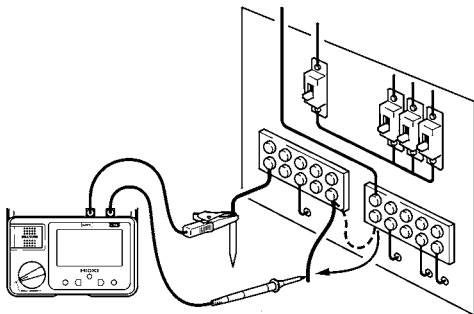

Ex. Checking the continuity of ground wiring

CAUTION

If an additional operating circuit is connected in parallel to the circuit under measurement, the measurement error may occur due to the effects of impedance of the circuit connected in parallel or transient currents.

2.9 PV Ω Measurement **IR4053**

PV Ω measurement of IR4053 is used to examine insulation performance of a solar panel. The PV Ω measurement allows accurate resistance measurements without the effect from power generation. See “Measurement Principles” (p. A1), “Insulation Resistance Measurements for Solar Cell Array” (p. A3).

The PV Ω measurement is used to measure insulation resistance between a solar panel and ground. Use normal insulation resistance range to measure the insulation resistance between an output terminal of a solar panel connection box and ground, and between a power conditioner and ground.

DANGER

Do not short-circuit two wires to be measured by bringing the metal part of the test lead into contact with them. It may cause a major accident such as arc.

 WARNING

To avoid electric shock, short circuits and damage to the instrument, observe the following precautions:

- When measuring insulation resistance, dangerous voltage is applied to the measurement terminals. Do not touch the metal part of the test leads.
 - Make sure that the measuring terminal has been connected securely. The increased resistance of loose connections can lead to overheating and fire.
 - Do not touch the object measured immediately after the measurement. High voltage charge may cause electrical shock.
 - Use discharge function of this instrument to discharge the object measured after the measurement. (p.36)
 - When you measure a solar panel, be sure to turn OFF disconnect switches to remove the solar panel from power conditioner.
 - Do not attempt to measure insulation resistance on a live conductor. Doing so could damage the instrument or cause an accident that might result in injury or death. Always turn off power to the conductor being measured before starting.
 - Solar panels always generate power and a dangerous voltage during the day. Pay full attention to the measurement not to cause any electrical shock.
 - Do not directly touch metal parts of a connection box or disconnection switches with your hand. High voltage being generated may cause electrical shock.
 - Maximum rated voltage between terminals of the IR4053 is 1000 V DC/600 V AC. Do not use this instrument for facilities using a voltage over 1000 V DC or 600 V AC. Doing so may cause an electrical shock or a failure.
-

WARNING

To avoid electric shock, short circuits and damage to the instrument, observe the following precautions:

- Measurements with P-N shorted should use an insulation resistance range other than PV Ω range.
 - During hours such as in the nighttime while a solar panel is not generating power, make measurements with P-N shorted.
 - Do not make any measurement if any of the bypass diodes of the solar panel has failed. Doing so may damage the solar panel.
-

NOTE

- Insulation resistance is a ratio of a voltage applied and a leakage current. Indication values are not sometimes stable depending on the object to be measured but it is not a failure.
- The **MEASURE** key should be fully pressed until the hot-line warning indication lights. Insufficient press may result in an incorrect measurement.
- After using this instrument, turn OFF the rotary switch.
- When you test an electrical line connected to equipment having a withstand voltage lower than the test voltage or equipment/part with an unknown withstand voltage, it is recommended to make any measurement after they are disconnected from the line.
- As solar panel to ground capacitance is larger, it may take time until measured values become stable.
- The PV measurement is an additional function of JIS C1302.
- The PVΩ measurement function does not comply with EN61557 requirements. To perform measurements in conformity with EN61557, select the insulation resistance range.
- If open voltage of solar cell string is higher than test voltage, accurate measurement cannot be achieved. PVΩ500 V range should be used with an open voltage 500 V or lower and PVΩ1000 V range for an open voltage 1000 V or lower.
- If a voltage higher than test voltage is being generated, no measurement is available.
- As PVΩ measurement uses a current-limiting resistor of 1 MΩ connected to EARTH terminal, the output voltage is divided by the 1 MΩ resistor and the resistor connected between the measuring terminals. For example, when a 10MΩ resistor is used, the output voltage is divided by 1 MΩ and 10 MΩ.

46 2.9 PVΩ Measurement

Insulation resistance measurement between a solar panel and ground without shorting P-N is explained as follows. For details, see “Insulation Resistance Measurements for Solar Cell Array” (p. A3).

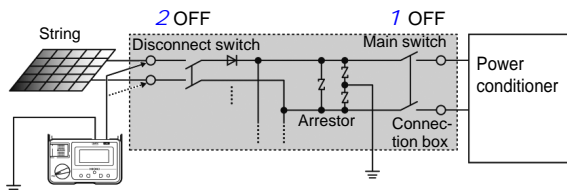

Measurement Preparations

1. Turn OFF the main switch of the connection box to be disconnected from power conditioner.
2. Turn OFF all disconnect switches used for strings.
3. If any arrestor is used for measuring path, disconnect it. As following figure does not use an arrestor for the string of disconnect switch, there is no need to disconnect any arrestor.



The figure shows an example of solar power generator. The configuration may be different from actual generator.

Starting Measurements

1. Check that the **MEASURE** key has been turned OFF.
If the key is pulled out, fold it back.
2. Set the rotary switch to PVΩ.
3. Press  and set the test voltage to 500 V or 1000 V.
4. Press  to release the lock.
5. Connect the black test lead to the ground terminal.
6. Connect the red test lead to terminal P of the string.

Note: If a voltage is being generated between terminal P and ground, there may be deteriorated insulation performance. If the object to be measured has a voltage, voltage detection make the display light in red and white alternately.

48 2.9 PVΩ Measurement

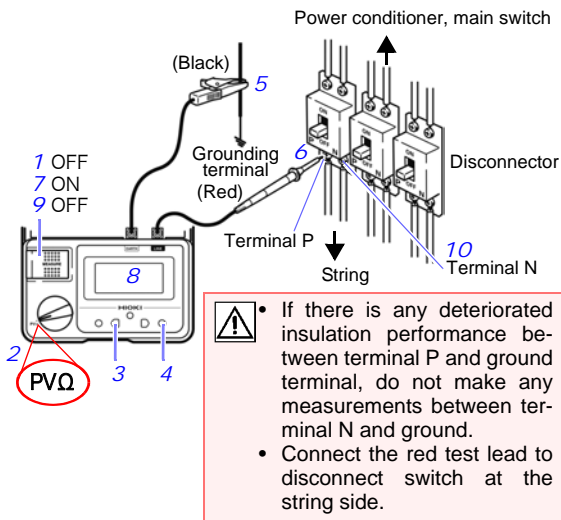

7. Press the **MEASURE** key.

To make continuous measurements, pull out the key.

Note: Do not disconnect the test leads until a resistance is indicated. If any of the lead is disconnected, no accurate measurement is available.

8. A resistance will be indicated after approximately four seconds (updated every one second).

Note: If there is any deteriorated insulation performance resulting in a resistance lower than a reference, do not make any measurement for terminal N of the procedure 10. Doing so may damage the solar panel. Check the insulation resistance reference in advance with safety standards.

9. Turn OFF the **MEASURE** key.
If the **MEASURE** key is pulled out, fold it back.
Discharging will be started to blink ⚡ mark. A voltage being generated by solar cell may not erase the ⚡ mark even if discharging is completed.
10. If there is no deteriorated insulation performance found with terminal P measurement, connect the red test lead to the terminal N of the string to make measurements by procedures from 7 through 9.

After Measurement

1. After insulation measurements for all the strings are completed, disconnect the black test lead from the ground terminal.
2. If arrestor has been disconnected, reconnect it.
3. Turn ON all disconnect switches used for strings.
4. Return main switch of the connection box to ON.

NOTE After one minute is elapsed from the last measurement or last operation, **PRESS RELEASE KEY** lights and 500V/1000V RELEASE key blinks. Press the key to release the lock.

2.10 Auto power save (power-saving function)

NOTE To avoid battery depletion, turn the rotary selector OFF after use (the Auto Power Save feature consumes a small amount of current).

When the rotary switch is in a position other than OFF, this instrument enters Auto Power Save mode approximately 10 minutes after the last operation or hot-line warning indication.

Disabling the power-saving function

Turn on the instrument while holding down .

Reviving from power save

Turn off the rotary selector and then return it to the original position.

2.11 Auto-backlight-off

The instrument's backlight will automatically turn off once approximately 3 minutes pass since the last operation. The auto-backlight-off function can be disabled as described below when working continuously in a dark location:

Disabling the auto-backlight-off function

While the backlight is off, press and hold  for about 2 minutes until a continuous beep-beep-beep sound is heard.

Repeat this procedure after turning the instrument off.

Specifications

Chapter 3

rdg. (reading or displayed value)

The value currently being measured and indicated on the measuring instrument.

dgt. (resolution)

The smallest displayable unit on a digital measuring instrument, i.e., the input value that causes the digital display to show a "1" as the least-significant digit.

Standard Specifications

Functions	Insulation Resistance measurement: DC voltage supply, current detection Low resistance measurement (except IR4053): DC current supply, voltage detection Voltage measurement: Automatic DC/AC detection PVΩ measurement (IR4053 only): DC voltage supply, current detection AC voltage measurement rectification method: Mean rectification RMS value indication Available effective battery voltage indicator: Battery power indicator
Live circuit indicator	Lights up when voltage is detected between LINE terminal and EARTH terminal
Automatic electric discharge	Automatically discharges the electric charge still present in the capacitance of the test object after the Insulation resistance measurement test.
Auto Power Save	Power automatically turns OFF approximately 10 minutes after the last operation or hot-line warning indication. Can be displayed using the power supply activation options.

Indicator	<p>Indicator: Semi-transmissive FSTN LCD, positive Backlight</p> <ul style="list-style-type: none"> • Colors: White, red • Light automatic OFF function : 3 min. after last operation • Turns red when the comparator judgment result is FAIL. • Operation at erroneous input: Alternates white and red.
-----------	--

General Specifications

Guaranteed accuracy period	1 year
Guaranteed accuracy period from adjustment made by Hioki	1 year
Product warranty period	3 years
Operating temperature and humidity (Rated operating conditions)	0°C to 40°C (32.0°F to 104.0°F) 90% RH or lower (non-condensing) 40°C to 50°C (104.0°F to 122.0°F), at 50°C and below relative with linear decrease up to 50% RH
Operating environment	Indoors, Pollution Degree 2 Altitude up to 2000 m (6562 ft.)
Nominal circuit voltage	600 V AC/DC max.
Storage temperature and humidity	-10°C to 50°C (14.0°F to 122.0°F) 90% RH or lower (non-condensing)
IP code	IP40
Maximum rated voltage between terminals	600 V AC/DC (Voltage measurement) 600V AC/1000 V DC (Volatage measurement, for IR4053 only)
Maximum rated voltage to earth	600 V AC/DC, Measurement Category III, Anticipated transient overvoltage: 6000 V
Dielectric strength	7060 V AC, 50 Hz/60 Hz, Measurement terminals - electrical enclosure, 1 min, current sensitivity 1 mA
Power source	Rated supply voltage: 1.5 V DC × 4 LR6 alkaline battery × 4

* The nominal circuit voltage refers to the nominal voltage of an electric distribution circuit that can be measured by this measuring instrument (based on EN 61557).

Maximum rated power	3 VA
Continuous operating time	Approx. 20 hours (Comparator off, backlight off, 500 V range, no load)
Dropproof	On concrete: 1 m
Fuse (Replacements)	FF0.5AH/1000V (70 172 40.0.500: SIBA) (Very fast acting, arc extinction type, high rupturing capacity type)
Dimensions (excluding protrusions)	IR4051, IR4053: Approx. 159Wx177Hx53D mm (6.26"Wx6.97"Dx2.09"D) IR4052: Approx. 152Wx92Hx40D mm (5.98"Wx3.62"Dx1.57"D)
Mass	IR4051, IR4053: Approx. 600g (21.2 oz.) IR4052: Approx. 440g (15.5 oz.) (including battery, excluding test lead)
Accessories	Refer to "Verifying Package Contents" (p.1).
Options	Refer to "Options" (p.3).
Standards	EN61326 (EMC) EN61557-1/-2/-4/-10* JISC1302 (Insulation resistance testers)

* Subclause 4.3 of Part 4 (Interchanging of test leads) is not applicable when L9788-10 is used.

* The IR4053 is not compatible with EN61557-4 and -10.

Measurement functions

Temperature and humidity for guaranteed accuracy:
 $23^{\circ}\text{C}\pm 5^{\circ}\text{C}$ ($73.4^{\circ}\text{F}\pm 8.5^{\circ}\text{F}$) and 90% RH or lower

Insulation Resistance Measurement					
Rated measurement voltage (DC)	50 V	125 V	250 V	500 V	1000 V
Effective maximum display value	100 M Ω	250 M Ω	500 M Ω	2000 M Ω	4000 M Ω
Effective medium value	2 M Ω	5 M Ω	10 M Ω	50 M Ω	100 M Ω
1st effective measuring range [M Ω]	0.200 to 10.00	0.200 to 25.0	0.200 to 50.0	0.200 to 500	0.200 to 1000
Accuracy (Intrinsic error)	$\pm 4\%$ rdg.				
2nd effective measuring range [M Ω]	10.1 to 100.0	25.1 to 250	50.1 to 500	501 to 2000	1010 to 4000
Accuracy (Intrinsic error)	$\pm 8\%$ rdg.				
Other measuring range [M Ω]	0 to 0.199				
Accuracy (Intrinsic error)	$\pm 2\%$ rdg. ± 6 dgt.				

Insulation Resistance Measurement						
Rated output voltage (DC)	50 V	125 V	250 V	500 V	1000 V	
Range configuration	Display range	1 MΩ	1 MΩ	1 MΩ	1 MΩ	1 MΩ
	Maximum display value	1.000 MΩ	1.000 MΩ	1.000 MΩ	1.000 MΩ	1.000 MΩ
	Resolution	0.001 MΩ	0.001 MΩ	0.001 MΩ	0.001 MΩ	0.001 MΩ
	Display range	10 MΩ	10 MΩ	10 MΩ	10 MΩ	10 MΩ
	Maximum display value	10.00 MΩ	10.00 MΩ	10.00 MΩ	10.00 MΩ	10.00 MΩ
	Resolution	0.01 MΩ	0.01 MΩ	0.01 MΩ	0.01 MΩ	0.01 MΩ
	Display range	100 MΩ	100 MΩ	100 MΩ	100 MΩ	100 MΩ
	Maximum display value	100.0 MΩ	100.0 MΩ	100.0 MΩ	100.0 MΩ	100.0 MΩ
	Resolution	0.1 MΩ	0.1 MΩ	0.1 MΩ	0.1 MΩ	0.1 MΩ
	Display range	—	250 MΩ	500 MΩ	1000 MΩ	1000 MΩ
	Maximum display value	—	250 MΩ	500 MΩ	1000 MΩ	1000 MΩ
	Resolution	—	1 MΩ	1 MΩ	1 MΩ	1 MΩ
	Display range	—	—	—	2000 MΩ	4000 MΩ
	Maximum display value	—	—	—	2000 MΩ	4000 MΩ
	Resolution	—	—	—	10 MΩ	10 MΩ

Insulation Resistance Measurement			
	1st effective measuring range	2nd effective measuring range	Other measuring range
Effect of temperature (E_2)*	$\pm 4\%$ rdg.	$\pm 8\%$ rdg.	$\pm 2\%$ rdg. ± 6 dgt.
Effect of humidity	$\pm 4\%$ rdg. and within allowance	$\pm 8\%$ rdg. and within allowance	$\pm 2\%$ rdg. ± 6 dgt.
Effect of external magnetic field	$\pm 2.4\%$ rdg.		
Effect of power supply (E_3)	$\pm 4\%$ rdg. and within allowance	$\pm 8\%$ rdg. and within allowance	$\pm 2\%$ rdg. ± 6 dgt. within allowance
Effect of position (E_1)	N/A		

* Effect of temperature (E_2) is applicable to the operating temperature range other than 18°C to 28°C.

Insulation Resistance Measurement					
Rated measurement voltage (DC)	50 V	125 V	250 V	500 V	1000 V
Possible number of measurements	1000 times or more				
Overload protection	600 V AC (10 s)				660 V AC (10 s)
	600 V AC (10 s), 1200 V DC (10s) for IR4053 only				
Display update interval	IR4052: Within 0.6 s (no update during response) IR4051, IR4053: Within 1.0 s (no update during response)				
Measurement terminal voltage characteristic					
Open-circuit voltage	1 to 1.2 times of rated measurement voltage				
Lower limit resistance value to be maintained rated measurement voltage	0.05 M Ω	0.125 M Ω	0.25 M Ω	0.5 M Ω	1 M Ω
Rated current	1 to 1.2 mA				
Short-circuit current	1.2 mA or less				
Response time	IR4052: Within 0.6 s (with resistance load) IR4051, IR4053: Within 1.0 s (with resistance load)				
Judgment time	IR4052: Within 0.3 s, IR4051, IR4053: Within 0.8 s (When switching from an open state to 10 times the default judgment reference value)				

Low Resistance Measurement				
Open-circuit voltage		4.0 V to 6.9 V		
Measuring current		200 mA or more (at 6 Ω or less* ¹)		
Effect of temperature* ²		$\pm 3\% \text{rdg.} \pm 2 \text{dgt.}$ (applicable to the operating temperature range other than 18°C to 28°C.)		
Effect of supply voltage* ²		$\pm 3\% \text{rdg.} \pm 2 \text{dgt.}$ and within allowance		
Response time		Within 1 s (measurement terminal open \rightarrow short)		
Possible number of measurements		200 times or more		
Overload protection		600 V AC (10 s, by Fuse)		
Zero adjustment range		0 Ω to 3 Ω		
Display update interval		Within 1 s		
Range configuration	Display range (Auto range)	Maximum display value	Resolution	Accuracy* ² (after zero adjustment)
	10 Ω	10.00 Ω	0.01 Ω	0 Ω to 0.19 Ω : $\pm 3 \text{dgt.}$
				0.20 Ω to 10.00 Ω : $\pm 3\% \text{rdg.} \pm 2 \text{dgt.}$
	100 Ω	100.0 Ω	0.1 Ω	$\pm 3\% \text{rdg.} \pm 2 \text{dgt.}$
1000 Ω	1000 Ω	1 Ω		

*1: Displayed value before zero adjustment

*2: Accuracy is applicable for displayed values after zero adjustment (when the temperature changes more than 1°C, zero adjustment is necessary)

Voltage Measurement				
AC/DC automatic detection range	AC detected at 30 V or greater (50 Hz/60 Hz) Any ripple current with superimposed current component at 30 V or higher is identified as alternate current.			
Effect of temperature	Measurement accuracy per 1°C × 0.1 (Applicable for operational temperature range excluding 18°C to 28°C)			
Overload protection	750 V AC (10 s), 750 V DC (10 s) 1200 V DC (10 s) for IR4053 only			
Display update interval	Within 1 s			
Response time	Within 1.2 s (when input voltage is raised from 0 V to 600 V)			
AC Voltage Measurement	Input resistance	100 kΩ or more (50 Hz/60 Hz)		
	Frequency range	50 Hz/60 Hz		
	Range configuration			
	Display range (Auto range)	Maximum display value	Resolution	Accuracy
	420 V (Min. display value: 30.0 V)	420.0 V	0.1 V	±2.3%rdg.±8dgt (Accuracy of range over 600 V is not guaranteed)
600 V	750 V	1 V		
DC Voltage Measurement	Input resistance	100 kΩ or more		
	Range configuration			
	Display range (Auto range)	Maximum display value	Resolution	Accuracy
	4.2 V	4.200 V	0.001 V	±1.3%rdg.±4dgt (Accuracy of range over 600 V* is not guaranteed)
	42 V	42.00 V	0.01 V	
420 V	420.0 V	0.1 V		
IR4051: 600 V IR4052: 600 V IR4053: 1000 V	IR4051: 750 V IR4052: 750 V IR4053: 1100 V	1 V		

*For only IR4053, the accuracy is guaranteed up to 1000 V.

PVΩ measurement (IR4053 only)

For PVΩ range configuration, see insulation resistance measurements for 500 V and 1000 V.

PVΩ measurement		
Measurement voltage (DC)	PVΩ 500 V	PVΩ 1000 V
Maximum display value	2000 MΩ	4000 MΩ
Measuring range [MΩ] Accuracy	0.200 to 500	0.200 to 1000
	±4%rdg.	
	501 to 2000	1010 to 4000
	±8%rdg.	
	0 to 0.199	
	±2%rdg. ±6dgt.	
Effect of temperature	Accuracy × 1.0 (Applicable for operational temperature range excluding 18°C to 28°C)	
Effect of humidity	Accuracy × 1.0 and within allowance	
Effect of external magnetic field	Accuracy × 0.5	
Effect of position	N/A	
Effect of power supply	Accuracy × 1.0 and within allowance	
Possible number of measurements	1000 times or more	
Overload protection	10 seconds at 660 V AC/ 10 seconds at 1200 V DC	
Display update interval (no update during in response)	Within 1.0 seconds	
Open-circuit voltage*	1 to 1.2 times of measurement voltage	
Short-circuit current	1.2 mA or less	
Response time	With in 4.0 s (Starting measurement to display)	

* As the PVΩ function employs a 1 MΩ current-limiting resistor at the EARTH terminal, the output voltage is divided by the 1 MΩ resistor and a resistor connected between measuring terminals.

For example for an open voltage measurement using a DMM with its input impedance at 10 MΩ, the output voltage is divided by the 1 MΩ and 10 MΩ.

Maintenance and Service

Chapter 4

4.1 Troubleshooting

 WARNING



Touching any of the high-voltage points inside the instrument is very dangerous.

Do not attempt to modify, disassemble or repair the instrument; as fire, electric shock and injury could result.

- If damage is suspected, check the “Before Returning for Repair” (p.62) section before contacting your authorized Hioki distributor or reseller.
- When sending the instrument for repair, remove the batteries and pack carefully to prevent damage in transit. Include cushioning material so the instrument cannot move within the package. Be sure to include details of the problem. Hioki cannot be responsible for damage that occurs during shipment.

Before Returning for Repair

If abnormal operation occurs, check the following items.

Symptom	Check Items
Unable to perform measurement.	<p>You will not be able to perform measurement if the rotary selector is set while pressing the MEASURE key.</p> <p>→ Turn off the MEASURE key and then press it again.</p>
	<p>You will not be able to perform measurement if the voltage between the measurement terminals before pressing the MEASURE key is higher than or equal to the following voltage:</p> <p>50 V to 250 V ranges: Approx. 90 V 500 V, PVΩ 500 V ranges: Approx. 500 V 1000 V, PVΩ 1000 V ranges: Approx. 1000 V</p> <p>→ Separate the measurement target from all sources of power before performing measurement.</p>
Unable to perform measurement in 500 V, 1000 V, or PVΩ range.	<p>The 500 V, 1000 V, and PVΩ ranges use double-action to prevent the inadvertent application of the measurement signal.</p> <p>→ Press  after setting the rotary selector to the 500 V or 1000 V range. Pressing  while holding the RELEASE key will not disable the lock function. In PVΩ range, select a voltage to be applied with 500 V ←→ 1000 V key and then press RELEASE key.</p>
The MEASURE key on the test lead with a remote control does not work.	<p>→ Connect the test lead with a remote control securely, plugging it all the way in as shown on p.23. The MEASURE key will not work if any gap remains.</p>
The measured value is shown as the maximum display value.	<p>There is a broken connection in a test lead.</p> <p>→ Check the continuity of the test lead with a tester.</p>
	<p>The test leads are not securely connected.</p> <p>→ Check the connection between the test leads and the instrument, and check the connection of the tips of the test leads.</p>

Symptom	Check Items
The batteries run out immediately.	You are using nickel-metal-hydride battery or manganese batteries. → Replace the batteries with alkaline batteries.
The instrument won't turn on.	The batteries are dead. → Replace the batteries.
	The batteries have been installed improperly. → Install the batteries in the proper orientation.
The insulation resistance measured value increases over time.	This phenomenon reflects the influence of the measurement target's capacitance component. → This is not a malfunction or error. If the measured value fluctuates gradually, wait for it to stabilize and then use that value.
There is excessive variation in the measured value. (With the IR4052, the measured value can be made easier to read by reducing the number of display digits.)	The variation is caused by induced noise from a charging circuit located near the measurement target. → Disconnect the circuit breaker for any nearby charging circuits. If this is not possible, use the lowest measured value as the measurement result.
	The measurement target has a large capacitance component (capacitor). → If it is possible to remove the capacitor, do so. If not, use the lowest measured value as the measurement result.

64 4.1 Troubleshooting

Symptom	Check Items
A different measured value results each time the same measurement target is measured.	The differences are due to the effects of the insulator's polarity. * → Allow an adequate amount of time (about 1 hour to 1 day) to pass after the first measurement before repeating measurement. The effects of polarity increase as the insulation resistance increases.
	The differences are due to the effects of the insulator's temperature characteristics. → Measure the target under the same temperature and humidity conditions. In general, an insulator's insulation resistance value will decrease as temperature and humidity increase. Reference: the insulation resistance value of some insulated cables decreases to 1/4 or less when the temperature increases 10°C.
When the instrument is calibrated, the accuracy of the insulation resistance range falls outside the device specifications.	The test lead cable insulation resistance is too low. → Use the test leads that came with the instrument or its optional test leads to perform the calibration procedure. With standard wiring, characteristics are affected when the resistance in the 1000 V range reaches or exceeds 100 MΩ. → Replace any test lead with its insulation performance deteriorated.
The output voltage polarity is reversed.	The reversal is due to the characteristics of the insulation ohmmeter. This does not represent a malfunction.
There are too few display digits (IR4052).	The instrument is set to the mode in which a lower number of display digits is used. → Set the rotary selector to the insulation resistance range and press  to set the instrument to the mode in which more display digits are displayed.

* Polarization: A phenomenon whereby a substance's positive and negative electric charges move in opposite directions when an electric field is applied to it, causing the center position of the positive and negative charges to shift.

Error Displays and Remedies

Display	Description	Remedy
Err1	The instrument was unable to perform zero adjustment. (Low resistance function)	Verify that there is no broken connection in the test leads. Zero adjustment can be performed for readings of up to $3\ \Omega$. Ensure that the wiring resistance is $3\ \Omega$ or less. This error may occur if a fuse other than the specified type is used. Use only the specified type of fuse.
Err2	The settings data has been corrupted.	Repair is required.
Err3	The pre-adjustment data has been corrupted.	Repair is required.
Err4	The measurement circuit is broken.	Repair is required.
Err6	The voltage generation circuit is broken.	Repair is required.
FUSE	There is a broken connection in the protective fuse.	Replace the indicated fuse. See: p.67

4.2 Replacing Batteries or Fuse



WARNING

- Replace only the specified fuse. Never use unspecified fuses and never use the instrument after the fuse holder has shorted. This will damage the instrument and cause injury.

Fuse type: FF0.5AH/1000V (70 172 40.0.500: SIBA)

(Very fast acting, arc extinction type, high rupturing capacity type)

Fuses can be purchased from your Hioki distributor.

- To avoid electric shock, turn off the rotary selector and disconnect the test leads from the object to be measured, before replacing the batteries or fuse.
- After replacing the batteries or fuse, replace the cover and screws before using the instrument.
- Battery may explode if mistreated. Do not short-circuit, recharge, disassemble or dispose of in fire.
- Handle and dispose of batteries in accordance with local regulations.
- To prevent instrument damage or electric shock, use only the screws for securing the battery cover in place that shipped with the product. If you have lost any screw or find that any screws are damaged, please contact your Hioki distributor for a replacement.

CAUTION

- Do not mix old and new batteries, or different types of batteries. Also, be careful to observe battery polarity during installation. Otherwise, poor performance or damage from battery leakage could result.
- To avoid corrosion and damage to this instrument from battery leakage, remove the batteries from the instrument if it is to be stored for a long time.

NOTE

- Please use only LR6 alkali batteries. Please do not use manganese, nickel-metal hydride or oxyride batteries.
- The IR4053 does not require any fuse replacement.

Back of the instrument

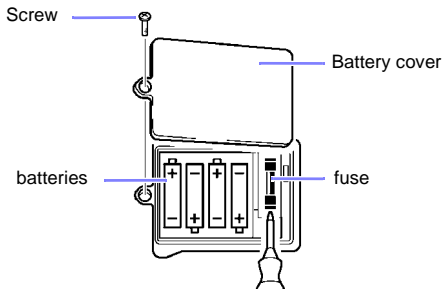

1. Turn the rotary selector to OFF and remove the test lead from the instrument as a precaution.
2. Loosen the central fastening screw at the back of the instrument and remove the battery cover.
3. Replace all four batteries or the fuse.
4. Slide the battery cover back into place and tighten the screw.

4.3 Replacing the Pin (Option)

The pin at the front of the Model L9788-10 (option) can be replaced when it has worn away or is damaged. Replacement pins are available at your authorized Hioki distributor or reseller. (Model L9788-90 Tip Pin)

1. Turn off the power of the instrument and disconnect the L9788-10.
2. Rotate the tip pin with a spanner (7 mm width) to remove it.

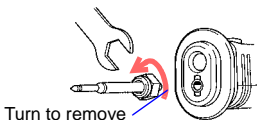

3. Turn the new tip pin with a spanner and attach it to the L9788-10. (tightening torque: 0.3N•m)
4. Check the performance. Measure an object with a known resistance. Make sure that the measured resistance is correct before using the L9788-10.

4.4 Cleaning

- To clean the instrument, wipe it gently with a soft cloth moistened with water or mild detergent. Never use solvents such as benzene, alcohol, acetone, ether, ketones, thinners or gasoline, as they can deform and discolor the case.
- Wipe the LCD gently with a soft, dry cloth.
- As dirt accumulated on the metal part of alligator clip has an effect on measurements, keep the surfaces clean by gently wiping with a soft cloth.

Appendix

Measurement Principles

1. Insulation resistance measurement

The measurement target's insulation resistance R_x is calculated by applying a voltage V to the target, measuring the leak current I that flows to the target as a result, and dividing the voltage V by the leak current I .

2. Low resistance measurement **IR4051** **IR4052**

The measurement target's resistance R_x is calculated by applying a current I to the measurement target, measuring the voltage V that occurs between the measurement terminals as a result, and dividing the voltage V by the current I .

3. $PV\Omega$ measurement **IR4053**

The measurement target's insulation resistance R_x is calculated by applying a voltage V to the target, measuring the leak current I that flows to the target as a result, and dividing the voltage V by the leak current I .

(Voltage and current generated by the object to be measured is subtracted.)

A2 Operation Uncertainty

Operation Uncertainty

The operation uncertainty and the variations of measurement value for the respective Influence quantity approved by EN/IEC61557 are as follows:

Intrinsic uncertainty/ Influence quantity		Operation range	Variation	
			Insulation resistance	Low resistance
A	Intrinsic uncertainty	Reference condition	$\pm 5\% \text{rdg.}$	$\pm 3\% \text{rdg.} \pm 2 \text{dgt.}$
E ₂	Supply voltage	4.5 V to 6.8 V	$\pm 4\% \text{rdg.}$	$\pm 3\% \text{rdg.} \pm 2 \text{dgt.}$
E ₃	Temperature	0°C to 35°C	$\pm 4\% \text{rdg.}$	$\pm 3\% \text{rdg.} \pm 2 \text{dgt.}$
B	Operation uncertainty		$\pm 12\% \text{rdg.}$	$\pm 30\% \text{rdg.}$
Guaranteed range of operation uncertainty			1st effective measurement range	0.2 Ω to 2 Ω

Influencing factor non-applicable for E₁ and E₄ to E₁₀

Insulation Resistance Measurements for Solar Cell Array

There are two insulation resistance measurements for solar cell arrays. Characteristics of them are as follows:

1. Measurement with P-N opened

PV Ω measurement of this manual is explained with this measurement.

As solar cell voltage influences the test voltage, the measurement may not be accurate. Incorrect procedure may damage the solar panel.

If earth fault is occurred due to earth leakage as shown in the following figure, current being generated influences the insulation resistance meter resulting in inaccurate measurement with a normal insulation resistance meter. *PV Ω measurement mode of the IR4053 allows accurate measurements without the effect from power generation.*

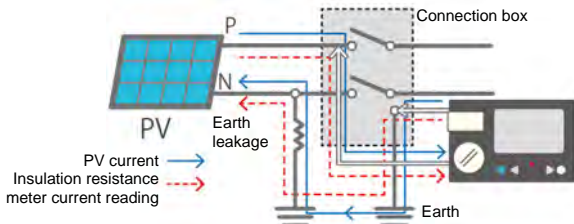

2. Measurement with P-N shorted

This measurement allows accurate measurements but is also a highly dangerous method as arc discharge may be generated due to the short circuit. There is also a fire risk depending on the deterioration level of the solar panel.

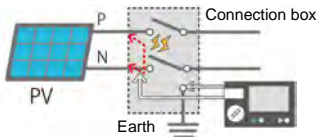

A4 *Insulation Resistance Measurements for Solar Cell Array*

Warranty Certificate

Model	Serial No.	Warranty period Three (3) years from date of purchase (__ / __)
-------	------------	--

This product passed a rigorous inspection process at Hioki before being shipped.

In the unlikely event that you experience an issue during use, please contact the distributor from which you purchased the product, which will be repaired free of charge subject to the provisions of this Warranty Certificate. This warranty is valid for a period of three (3) years from the date of purchase. If the date of purchase is unknown, the warranty is considered valid for a period of three (3) years from the product's date of manufacture. Please present this Warranty Certificate when contacting the distributor. Accuracy is guaranteed for the duration of the separately indicated guaranteed accuracy period.

- Malfunctions occurring during the warranty period under conditions of normal use in conformity with the Instruction Manual, product labeling (including stamped markings), and other precautionary information will be repaired free of charge, up to the original purchase price. Hioki reserves the right to decline to offer repair, calibration, and other services for reasons that include, but are not limited to, passage of time since the product's manufacture, discontinuation of production of parts, or unforeseen circumstances.
- Malfunctions that are determined by Hioki to have occurred under one or more of the following conditions are considered to be outside the scope of warranty coverage, even if the event in question occurs during the warranty period:
 - Damage to objects under measurement or other secondary or tertiary damage caused by use of the product or its measurement results
 - Malfunctions caused by improper handling or use of the product in a manner that does not conform with the provisions of the Instruction Manual
 - Malfunctions or damage caused by repair, adjustment, or modification of the product by a company, organization, or individual not approved by Hioki
 - Consumption of product parts, including as described in the Instruction Manual
 - Malfunctions or damage caused by transport, dropping, or other handling of the product after purchase
 - Changes in the product's appearance (scratches on its enclosure, etc.)
 - Malfunctions or damage caused by fire, wind or flood damage, earthquakes, lightning, power supply anomalies (including voltage, frequency, etc.), war or civil disturbances, radioactive contamination, or other acts of God
 - Damage caused by connecting the product to a network
 - Failure to present this Warranty Certificate
 - Failure to notify Hioki in advance if used in special embedded applications (space equipment, aviation equipment, nuclear power equipment, life-critical medical equipment or vehicle control equipment, etc.)
 - Other malfunctions for which Hioki is not deemed to be responsible

***Requests**

- Hioki is not able to reissue this Warranty Certificate, so please store it carefully.
- Please fill in the model, serial number, and date of purchase on this form.

13-09

HIOKI E.E. CORPORATION

81 Koizumi, Ueda, Nagano 386-1192, Japan
TEL: +81-268-28-0555
FAX: +81-268-28-0559

- Please visit our website at www.hioki.com for the following:
 - Regional contact information
 - The latest revisions of instruction manuals and manuals in other languages.
 - Declarations of Conformity for instruments that comply with CE mark requirements.
- All reasonable care has been taken in the production of this manual, but if you find any points which are unclear or in error, please contact your supplier or the International Sales and Marketing Department at Hioki headquarters.
- In the interests of product development, the contents of this manual are subject to revision without prior notice.
- The content of this manual is protected by copyright.
No reproduction, duplication or modification of the content is permitted without the authorization of Hioki E.E. Corporation.

HIOKI

HIOKI E. E. CORPORATION

HEADQUARTERS

81 Koizumi, Ueda, Nagano 386-1192, Japan
TEL +81-268-28-0562 FAX +81-268-28-0568
os-com@hioki.co.jp
(International Sales Department)

www.hioki.com

HIOKI USA CORPORATION

hioki@hiokiusa.com www.hiokiusa.com

HIOKI (Shanghai) SALES & TRADING CO., LTD.

info@hioki.com.cn www.hioki.cn

HIOKI INDIA PRIVATE LIMITED

hioki@hioki.in www.hioki.in

HIOKI SINGAPORE PTE. LTD.

info@hioki.com.sg

1502EN