

# **1587/1577**

Insulation Multimeters

## Calibration Manual

PN 2456783

September 2005 Rev. 1, 6/09

© 2005, 2009 Fluke Corporation, All rights reserved. Printed in USA. Specifications are subject to change without notice.  
All product names are trademarks of their respective companies.

## **LIMITED WARRANTY AND LIMITATION OF LIABILITY**

Each Fluke product is warranted to be free from defects in material and workmanship under normal use and service. The warranty period is three years and begins on the date of shipment. Parts, product repairs, and services are warranted for 90 days. This warranty extends only to the original buyer or end-user customer of a Fluke authorized reseller, and does not apply to fuses, disposable batteries, or to any product which, in Fluke's opinion, has been misused, altered, neglected, contaminated, or damaged by accident or abnormal conditions of operation or handling. Fluke warrants that software will operate substantially in accordance with its functional specifications for 90 days and that it has been properly recorded on non-defective media. Fluke does not warrant that software will be error free or operate without interruption.

Fluke authorized resellers shall extend this warranty on new and unused products to end-user customers only but have no authority to extend a greater or different warranty on behalf of Fluke. Warranty support is available only if product is purchased through a Fluke authorized sales outlet or Buyer has paid the applicable international price. Fluke reserves the right to invoice Buyer for importation costs of repair/replacement parts when product purchased in one country is submitted for repair in another country.

Fluke's warranty obligation is limited, at Fluke's option, to refund of the purchase price, free of charge repair, or replacement of a defective product which is returned to a Fluke authorized service center within the warranty period.

To obtain warranty service, contact your nearest Fluke authorized service center to obtain return authorization information, then send the product to that service center, with a description of the difficulty, postage and insurance prepaid (FOB Destination). Fluke assumes no risk for damage in transit. Following warranty repair, the product will be returned to Buyer, transportation prepaid (FOB Destination). If Fluke determines that failure was caused by neglect, misuse, contamination, alteration, accident, or abnormal condition of operation or handling, including overvoltage failures caused by use outside the product's specified rating, or normal wear and tear of mechanical components, Fluke will provide an estimate of repair costs and obtain authorization before commencing the work. Following repair, the product will be returned to the Buyer transportation prepaid and the Buyer will be billed for the repair and return transportation charges (FOB Shipping Point).

**THIS WARRANTY IS BUYER'S SOLE AND EXCLUSIVE REMEDY AND IS IN LIEU OF ALL OTHER WARRANTIES, EXPRESS OR IMPLIED, INCLUDING BUT NOT LIMITED TO ANY IMPLIED WARRANTY OF MERCHANTABILITY OR FITNESS FOR A PARTICULAR PURPOSE. FLUKE SHALL NOT BE LIABLE FOR ANY SPECIAL, INDIRECT, INCIDENTAL OR CONSEQUENTIAL DAMAGES OR LOSSES, INCLUDING LOSS OF DATA, ARISING FROM ANY CAUSE OR THEORY.**

Since some countries or states do not allow limitation of the term of an implied warranty, or exclusion or limitation of incidental or consequential damages, the limitations and exclusions of this warranty may not apply to every buyer. If any provision of this Warranty is held invalid or unenforceable by a court or other decision-maker of competent jurisdiction, such holding will not affect the validity or enforceability of any other provision.

Fluke Corporation  
P.O. Box 9090  
Everett, WA 98206-9090  
U.S.A.

Fluke Europe B.V.  
P.O. Box 1186  
5602 BD Eindhoven  
The Netherlands

# Table of Contents

Title	Page
Introduction.....	1
Safety Information .....	1
Contacting Fluke.....	2
General Specifications .....	2
Electrical Specifications .....	3
AC Voltage Measurement .....	3
1587 Accuracy .....	3
1587 Low-pass Filter Voltage .....	3
1577 Accuracy .....	3
DC Voltage Measurement .....	4
DC Millivolts Measurement .....	4
DC and AC Current Measurement .....	4
Ohms Measurement.....	4
Diode Test (1587 Only).....	4
Continuity Test.....	5
Frequency Measurement (1587 Only).....	5
Frequency Counter Sensitivity .....	5
Capacitance (1587 Only).....	5
Temperature Measurement (1587 Only) .....	5
Insulation Specifications .....	5
Model 1587 .....	6
Model 1577 .....	6
Basic Maintenance .....	6
Cleaning.....	6
Testing the Batteries Under Load.....	6
Testing the Fuse.....	7
Replacing the Batteries and/or Fuse .....	8
Testing the Display.....	9
Testing the Backlight.....	9
Testing the Keypad.....	9
Disassembling and Reassembling the Meter .....	10
Removing the Boot.....	11
Removing the Battery Door.....	11
Removing the Bottom Case.....	12
Removing the PCA.....	12

Removing the LCD.....	13
Replacing the LCD.....	13
Reassembling the Meter.....	15
Required Tools and Equipment.....	15
Performance Test.....	16
Testing the 1577 and 1587 DMM Functions.....	16
Testing Temperature Function (1587 Only).....	18
Testing the Discharge Circuit.....	18
Testing the Insulation Function.....	18
Insulation Resistance Accuracy Test.....	18
Insulation Function, External Sense.....	19
Insulation Function, Source Voltage Accuracy Test.....	20
I Nominal Test.....	21
Low-Battery Test - DMM Function.....	21
Low-Battery Test - INSULATION Function.....	22
Calibration Adjustment Procedure.....	23
Calibration Adjustment Counter.....	23
Calibration Adjustment Password.....	23
Changing the Password.....	23
Restoring the Default Password.....	23
Meter Keys Used in the Calibration Steps.....	25
Calibration Adjustment.....	25
Service and Parts.....	27

# ***List of Tables***

<b>Table</b>	<b>Title</b>	<b>Page</b>
1.	Description of Symbols Used in the Manual.....	1
2.	Required Tools and Equipment.....	15
3.	DMM Accuracy Tests.....	16
4.	Insulation Resistance Accuracy Test.....	19
5.	Insulation Mode, Source Voltage Accuracy Tests.....	20
6.	Calibration Adjustment Steps.....	26
7.	1587/1577 Replacement Parts.....	28



# ***List of Figures***

<b>Figure</b>	<b>Title</b>	<b>Page</b>
1.	Testing the Fuse .....	7
2.	Replacing the Batteries and Fuse .....	8
3.	LCD Display Test .....	9
4.	Disassembling the Meter.....	10
5.	Insulation Terminal Clips.....	13
6.	Accessing the LCD .....	14
7.	Source Voltage Accuracy Test.....	20
8.	I Nominal Test.....	21
9.	Low-Battery Test Connections.....	22
10.	Restoring the Default Password .....	24
11.	1587/1577 Replacement Parts .....	27





## Introduction

The Fluke Model 1587, and Model 1577 are battery-powered, true-rms insulation multimeters (hereafter, Meter or UUT) with a 6000-count and a 3 ¾ digit display. Although this manual contains calibration information for Models 1587 and 1577, all illustrations and examples assume use of the Model 1587. Table 1 provides a description of all the symbols used in this manual.

The Meter meets CAT III and CAT IV IEC 61010 standards. The IEC 61010 standard defines four measurement categories (CAT I to IV) based on the magnitude of danger from transient impulses. CAT III meters are designed to protect against transients in fixed equipment installations at the distribution level; CAT IV meters are designed to protect against transients from the primary supply level (overhead or underground utility service).

## Safety Information

### ⚠ ⚠ Warning

To avoid possible electric shock or personal injury, follow these guidelines:

- Use the Meter only as specified in this manual or the protection provided by the Meter might be impaired.
- Do not use the Meter or test leads if they appear damaged, or if the Meter is not operating properly. If in doubt, have the Meter serviced.
- Always use the proper terminal, switch position, and range for measurements before connecting the Meter to circuit under test.
- Verify that the Meter is operational by measuring a known voltage.
- Do not apply more than the rated voltage as marked on the Meter, between the terminals or between any terminal and earth ground.
- Use caution with voltages above 30 V ac rms, 42 V ac peak, or 60 V dc. These voltages pose a shock hazard.
- Replace the battery as soon as the low battery indicator (🔋) appears.
- Disconnect circuit power and discharge all high-voltage capacitors before testing resistance, continuity, diodes, or capacitance.
- Do not use the Meter around explosive gas or vapor.
- When using the test leads, keep your fingers behind the finger guards.
- Remove test leads from the Meter before opening the Meter case or battery door. Never operate the Meter with the back case removed or the battery door open.
- Comply with local and national safety requirements when working in hazardous locations.
- Use proper protective equipment, as required by local or national authorities when working in hazardous areas.
- Avoid working alone.
- Use only the replacement fuse specified or the protection may be impaired.
- Check the test leads for continuity before use. Do not use if the readings are high or noisy.

**Table 1. Description of Symbols Used in the Manual**

~	AC (Alternating Current)	⏚	Earth Ground
—	DC (Direct Current)	⊞	Fuse
⚠	WARNING: risk of electric shock.	⊞	Double Insulated
🔋	Battery (Low battery when shown on display.)	⚠	Important information; see manual
♻	Do not dispose of this product as unsorted municipal waste. Go to Fluke's website for recycling information.		

## Contacting Fluke

To contact Fluke, call one of the following telephone numbers:

- Technical Support USA: 1-800-44-FLUKE (1-800-443-5853)
- Calibration/Repair USA: 1-888-99-FLUKE (1-888-993-5853)
- Canada: 1-800-36-FLUKE (1-800-363-5853)
- Europe: +31 402-675-200
- Japan: +81-3-3434-0181
- Singapore: +65-738-5655
- Anywhere in the world: +1-425-446-5500

Or, visit Fluke's website at [www.fluke.com](http://www.fluke.com).

To register your product, visit <http://register.fluke.com>.

To view, print, or download the latest manual supplement, visit <http://us.fluke.com/usen/support/manuals>.

## General Specifications

Maximum Voltage Applied to any Terminal .....	1000 V ac rms or dc
Storage Temperature.....	-40 °C to 60 °C (-40 °F to 140 °F)
Operating Temperature .....	-20 °C to 55 °C (-4 °F to 131 °F)
Temperature Coefficient .....	0.05 x (specified accuracy) per °C for temperatures <18 °C or >28 °C (< 64 °F or > 82 °F)
Relative Humidity.....	Noncondensing 0 % to 95 % @ 10 °C to 30 °C (50 °F to 86 °F) 0 % to 75 % @ 30 °C to 40 °C (86 °F to 104 °F) 0 % to 40 % @ 40 °C to 55 °C (104 °F to 131 °F)
Vibration.....	Random, 2 g, 5-500 Hz per MIL-PRF-28800F, Class 2 instrument
Shock .....	1 meter drop per IEC 61010-1 2 <sup>nd</sup> Edition (1 meter drop test, six sides, oak floor)
Electromagnetic Compatibility .....	In an RF field of 3 V/M, accuracy = specified accuracy except in temperature: accuracy = specified accuracy ± 5 °C (9 °F). (EN 61326-1:1997).
Safety .....	Complies with ANSI/ISA 82.02.01 (61010-1) 2004, CAN/CSA-C22.2 NO. 61010-1-04, and IEC/EN 61010-1 2 <sup>nd</sup> Edition for measurement category III 1000 V (CAT III) and CAT IV 600 V.
Certifications .....	CSA per standard CSA/CAN C22.2 No. 61010.1-04; TUV per standard EN 61010 Part 1-1002
Batteries.....	Four AA batteries (NEDA 15A or IEC LR6)
Battery Life.....	Meter use 1000 hours; Insulation test use: Meter can perform at least 1000 insulation tests with fresh alkaline batteries at room temperature. These are standard tests of 1000 V into 1 MΩ with a duty cycle of 5 seconds on and 25 seconds off.
Size .....	5.0 cm H x 10.0 cm W x 20.3 cm L (1.97 in H x 3.94 in W x 8.00 in L)
Weight.....	550 g (1.2 lb.)
IP Rating .....	IP40
Altitude	
Operating .....	2000 m CAT III 1000 V, CAT IV 600 V; 3000 m CAT II 1000 V, CAT III 600 V
Storage .....	12,000 m
Over-Range Capability .....	110% of range except for capacitance which is 1 %
Compliance to EN 61557 .....	IEC61557-1, IEC61557-2

## Electrical Specifications

### AC Voltage Measurement

#### 1587 Accuracy

Range	Resolution	50 Hz to 60 Hz $\pm(\% \text{ of Rdg} + \text{ Digits})$	60 Hz to 5000 Hz $\pm(\% \text{ of Rdg} + \text{ Digits})$
600.0 mV	0.1 mV	$\pm(1 \% + 3)$	$\pm(2 \% + 3)$
6.000 V	0.001 V	$\pm(1 \% + 3)$	$\pm(2 \% + 3)$
60.00 V	0.01 V	$\pm(1 \% + 3)$	$\pm(2 \% + 3)$
600.0 V	0.1 V	$\pm(1 \% + 3)$	$\pm(2 \% + 3)$ <sup>[1]</sup>
1000 V	1 V	$\pm(2 \% + 3)$	$\pm(2 \% + 3)$ <sup>[1]</sup>

[1] 1 kHz bandwidth.

#### 1587 Low-pass Filter Voltage

Range	Resolution	50 Hz to 60 Hz $\pm(\% \text{ of Rdg} + \text{ Digits})$	60 Hz to 400 Hz $\pm(\% \text{ of Rdg} + \text{ Digits})$
600.0 mV	0.1 mV	$\pm(1 \% + 3)$	+ (2 % + 3) - (6 % - 3)
6.000 V	0.001 V	$\pm(1 \% + 3)$	+ (2 % + 3) - (6 % - 3)
60.00 V	0.01 V	$\pm(1 \% + 3)$	+ (2 % + 3) - (6 % - 3)
600.0 V	0.1 V	$\pm(1 \% + 3)$	+ (2 % + 3) - (6 % - 3)
1000 V	1 V	$\pm(2 \% + 3)$	+ (2 % + 3) - (6 % - 3)

#### 1577 Accuracy

Range	Resolution	50 Hz to 60 Hz $\pm(\% \text{ of Rdg} + \text{ Digits})$
600.0 mV	0.1 mV	$\pm(2 \% + 3)$
6.000 V	0.001 V	$\pm(2 \% + 3)$
60.00 V	0.01 V	$\pm(2 \% + 3)$
600.0 V	0.1 V	$\pm(2 \% + 3)$
1000 V	1 V	$\pm(2 \% + 3)$

AC Conversion..... Inputs are ac-coupled and calibrated to the rms value of sine wave input. Conversions are true-rms responding and specified from 5 % to 100 % of range. Input signal crest factor can be up to 3 at up to 500 V, decreasing linearly to crest factor  $\leq 1.5$  at 1000 V. For non-sinusoidal waveforms add  $\pm(2 \% \text{ reading} + 2 \% \text{ FS})$  typical, for a crest factor up to 3.

Input Impedance ..... 10 M $\Omega$  (nominal), <100 pF, ac-coupled

Common Mode Rejection Ratio

(1 k $\Omega$  unbalanced) ..... >60 dB at dc, 50 or 60 Hz

Overload Protection ..... 1000 V rms or dc, 10<sup>7</sup> V Hz Max

### DC Voltage Measurement

Range	Resolution	Accuracy 1587 <sup>[1]</sup> ±(% of Rdg + Digits)	Accuracy 1577 <sup>[1]</sup> ±(% of Rdg + Digits)
6.000 V dc	0.001 V	±(0.09 % + 2)	±(0.2 % + 2)
60.00 V dc	0.01 V	±(0.09 % + 2)	±(0.2 % + 2)
600.0 V dc	0.1 V	±(0.09 % + 2)	±(0.2 % + 2)
1000 V dc	1 V	±(0.09 % + 2)	±(0.2 % + 2)

[1] Accuracies apply to ± 100% of range.

Input Impedance ..... 10 MΩ (nominal), <100 pF  
 Normal Mode Rejection Ratio ..... >60 dB @ 50 Hz or 60 Hz  
 Common Mode Rejection Ratio ..... >120 dB @ dc, 50 Hz or 60 Hz (1 k unbalance)  
 Overload Protection ..... 1000 V rms or dc

### DC Millivolts Measurement

Range	Resolution	Accuracy 1587 ±(% of Rdg + Digits)	Accuracy 1577 ±(% of Rdg + Digits)
600.0 mV dc	0.1 mV	±(0.1 % + 1)	±(0.2 % + 1)

### DC and AC Current Measurement

Range	Resolution	Accuracy 1587 ±(% of Rdg+Digits)	Accuracy 1577 ±(% of Rdg+Digits)	Burden Voltage (Typical)	
AC 45 Hz to 1000 Hz	400 mA	0.1 mA	±(1.5 % + 2) <sup>[1]</sup>	±(2 % + 2) <sup>[1]</sup>	2 mV/mA
	60 mA	0.01 mA	±(1.5 % + 2) <sup>[1]</sup>	±(2 % + 2) <sup>[1]</sup>	
DC	400 mA	0.1 mA	±(0.2 % + 2)	±(1.0 % + 2)	2 mV/mA
	60 mA	0.01 mA	±(0.2 % + 2)	±(1.0 % + 2)	

[1] 1 kHz bandwidth.

Overload ..... 600 mA for 2 minutes maximum  
 Overload Protection ..... 440 mA, 1000 V, FAST fuse  
 AC Conversion ..... Inputs are ac-coupled and calibrated to the rms value of sine wave input. Conversions are true-rms responding and specified from 5 % to 100 % of range. Input signal crest factor can be up to 3 up to 300 mA, decreasing linearly to crest factor ≤ 1.5 at 600 mA. For non-sinusoidal waveforms add +(2 % reading + 2 % FS) typical, for a crest factor up to 3.

### Ohms Measurement

Range	Resolution	Accuracy 1587 <sup>[1]</sup> +(% of Rdg+Digits)	Accuracy 1577 <sup>[1]</sup> +(% of Rdg+Digits)
600.0 Ω	0.1 Ω	±(0.9 % + 2)	±(1.2 % + 2)
6.000 kΩ	0.001 kΩ		
60.00 kΩ	0.01 kΩ		
600.0 kΩ	0.1 KΩ		
6.000 MΩ	0.001 MΩ	±(1.5 % + 3)	±(2.0 % + 3)
50.0 MΩ	0.01 MΩ		

[1] Accuracies apply from 0 to 100% of range.

Overload Protection ..... 1000 V rms or dc  
 Open Circuit Test Voltage ..... <8.0 V dc  
 Short Circuit Current ..... <1.1 mA

### Diode Test (1587 Only)

Diode Test Indication ..... Display voltage drop: 0.6 V at 1.0 mA nominal test current:  
 Accuracy ..... ±(2 % + 3)

### Continuity Test

Continuity Indication .....	Continuous audible tone for test resistance below 25 Ω and off above 100 Ω. Maximum Reading; 1000 Ω
Open Circuit Voltage.....	<8.0 V
Short Circuit Current .....	1.0 mA typical
Overload Protection.....	1000 V rms
Response Time.....	>1 m sec

### Frequency Measurement (1587 Only)

Range	Resolution	Accuracy ±(% of Rdg+Digits)
99.99 Hz	0.01 Hz	±(0.1 % + 1)
999.9 Hz	0.1 Hz	±(0.1 % + 1)
9.999 kHz	0.001 kHz	±(0.1 % + 1)
99.99kHz	0.01 kHz	±(0.1 % + 1)

### Frequency Counter Sensitivity

Input Range	V ac Sensitivity (RMS Sine Wave) <sup>[1]</sup>		DC Trigger Levels <sup>[1]</sup> to 20 kHz <sup>[2]</sup>
	5 Hz to 20 kHz	20 kHz to 100 kHz	
600.0 mV ac	100.0 mV	150.0 mV	na
6.0 V	1.0 V	1.5 V	-400.0 mV and 2.5 V
60.0 V	10.0 V	36.0 V	1.2 V and 4.0 V
600.0 V	100.0 V	-	12.0 V and 40.0 V
1000.0 V	300.0 V	-	12.0 V and 40.0 V

[1] Maximum input for specified accuracy = 10x range (1000 V max). Noise at low frequencies and amplitudes may affect accuracy.  
[2] Usable to 100 kHz with full scale input.

### Capacitance (1587 Only)

Range	Resolution	Accuracy ±(% of Rdg+Digits)
1000 nF	1 nF	±(1.2 % + 2)
10.00 μF	0.01 μF	
100.0 μF	0.1 μF	±(1.2 % +/- 90 counts)
9999 μF	1 μF	

### Temperature Measurement (1587 Only)

Range	Resolution	Accuracy <sup>[1]</sup> ±(% of Rdg+Digits)
-40 °C to 537 °C	0.1 °C	±(1 % + 10 counts)
-40 °F to 998 °F	0.1 °F	±(1 % + 18 counts)

[1] Accuracies apply following 90 minutes settling time after a change in the ambient temperature of the instrument.

### Insulation Specifications

Measurement Range .....	0.1 MΩ to 2 GΩ model 1587, 0.1 MΩ to 600 MΩ model 1577
Test Voltages .....	50, 100, 250, 500, 1000 V model 1587, 500 and 1000 V model 1577
Test Voltage Accuracy.....	+20 %, - 0 %
Short-Circuit Test Current.....	1 mA nominal
Auto Discharge .....	Discharge time <0.5 second for C = 1 μF or less
Live Circuit Detection:.....	Inhibit test if terminal voltage >30 V prior to initialization of test.
Maximum Capacitive Load .....	Operable with up to 1 μF load.

### Model 1587

Output Voltage	Display Range	Resolution	Test Current	Resistance Accuracy ±(% of Rdg + Digits)
50 V (0 % to + 20 %)	0.01 to 6.00 MΩ	0.01 MΩ	1 mA @ 50 kΩ	±(3 % + 5 counts)
	6.0 to 50.0 MΩ	0.1 MΩ		
100 V (0 % to + 20 %)	0.01 to 6.00 MΩ	0.01 MΩ	1 mA @ 100 kΩ	±(3 % + 5 counts)
	6.0 to 60.0 MΩ	0.1 MΩ		
	60 to 100 MΩ	1 MΩ		
250 V (0 % to + 20 %)	0.1 to 60.0 MΩ	0.1 MΩ	1 mA @ 250 kΩ	±(1.5 % + 5 counts)
	60 to 250 MΩ	1 MΩ		
500 V (0 % to + 20 %)	0.1 to 60.0 MΩ	0.1 MΩ	1 mA @ 500 kΩ	±(1.5 % + 5 counts)
	60 to 500 MΩ	1 MΩ		
1000 V (0 % to + 20 %)	0.1 to 60.0 MΩ	0.1 MΩ	1 mA @ 1 MΩ	±(1.5 % + 5 counts)
	60 to 600 MΩ	1 MΩ		
	0.6 to 2.0 GΩ	100 MΩ		±(10 % + 3 counts)

### Model 1577

Output Voltage	Display Range	Resolution	Test Current	Resistance Accuracy ±(% of Rdg + Digits)
500 V (0 % to + 20 %)	0.1 to 60.0 MΩ	0.1 MΩ	1 mA @ 500 kΩ	±(2.0 % + 5 counts)
	60 to 500 MΩ	1 MΩ		
1000 V (0 % to + 20 %)	0.1 to 60.0 MΩ	0.1 MΩ	1 mA @ 1 MΩ	±(2.0 % + 5 counts)

#### Note

Throughout this manual “rotary switch” refers to the rotary function switch on the Meter.

## Basic Maintenance

This basic maintenance section of the manual contains tests and procedures that require no equipment other than the Meter and some consumables such as fuses and batteries. Also, internal access is limited to the battery and fuse compartment.

### Cleaning

When cleaning is necessary, wipe the Meter with a damp cloth and mild detergent. Do not use abrasives or solvents. Dirt or moisture on the terminals can affect readings.

### Testing the Batteries Under Load

#### ⚠ ⚠ Warning

**To avoid electrical shock or personal injury, replace the batteries as soon as the battery indicator (⚡) appears. A weak battery can cause false readings.**

Before testing the batteries, turn the Meter to  $\tilde{V}$ . If **⚡** appears on the display, the batteries are weak; replace them. If the display is blank, batteries may not be present in the Meter, or they may be completely discharged; install new batteries.

The following procedure tests the batteries under load:

1. Depress the **HOLD** while turning the rotary switch to **INSULATION**.
2. Read the display. The displayed voltage should be 5.2 V or greater. If voltage is lower than 5.2 V, replace the batteries and repeat this test.



# static awareness



A Message From  
Fluke Corporation

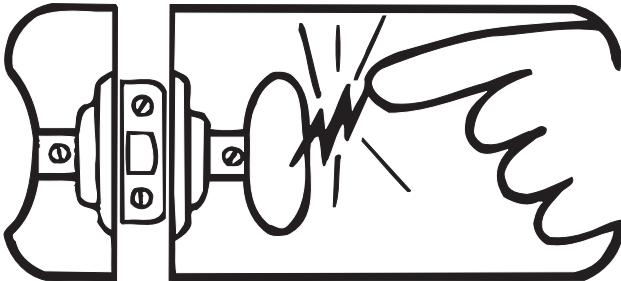

Some semiconductors and custom IC's can be damaged by electrostatic discharge during handling. This notice explains how you can minimize the chances of destroying such devices by:

1. Knowing that there is a problem.
2. Learning the guidelines for handling them.
3. Using the procedures, packaging, and bench techniques that are recommended.

The following practices should be followed to minimize damage to S.S. (static sensitive) devices.

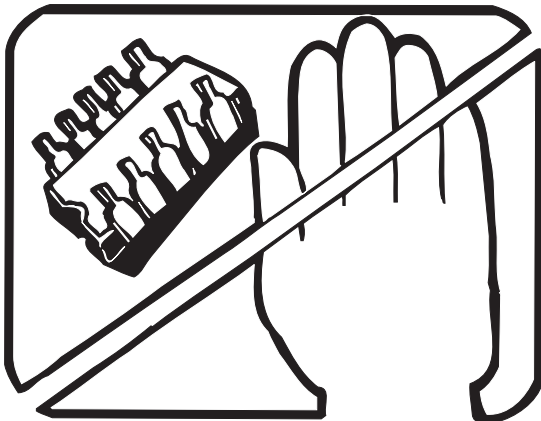

1. MINIMIZE HANDLING

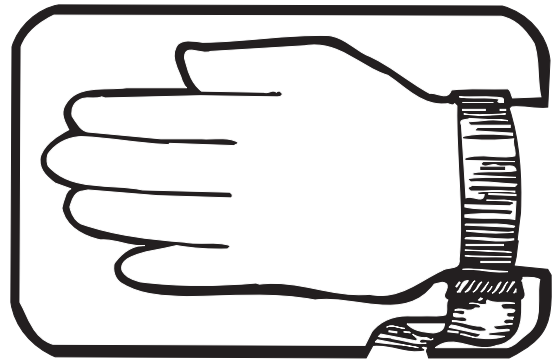

3. DISCHARGE PERSONAL STATIC BEFORE HANDLING DEVICES. USE A HIGH RESISTANCE GROUNDING WRIST STRAP.

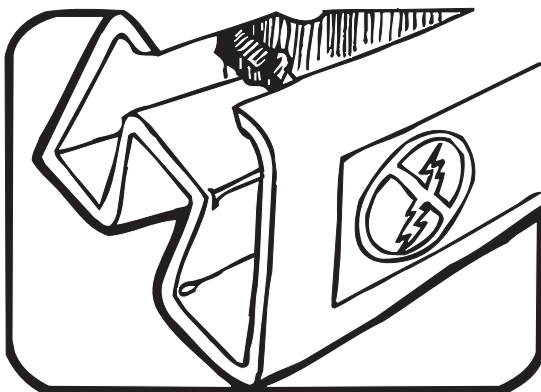

2. KEEP PARTS IN ORIGINAL CONTAINERS UNTIL READY FOR USE.

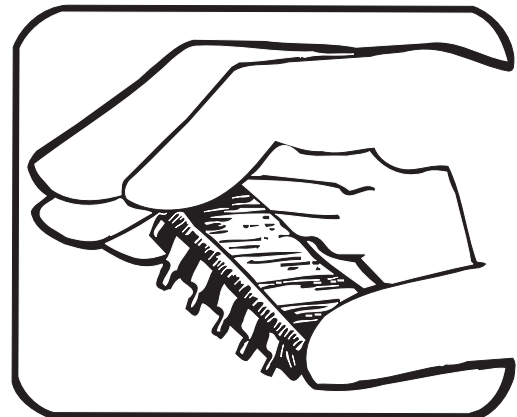

4. HANDLE S.S. DEVICES BY THE BODY.

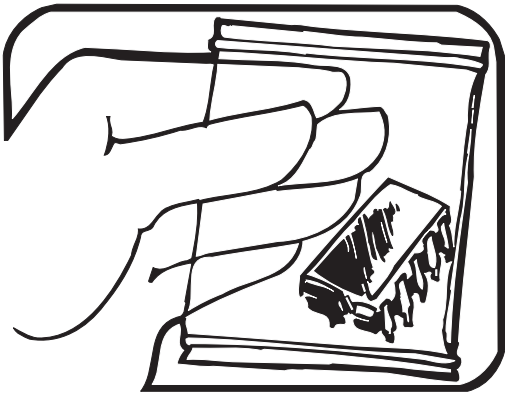

5. USE STATIC SHIELDING CONTAINERS FOR HANDLING AND TRANSPORT.

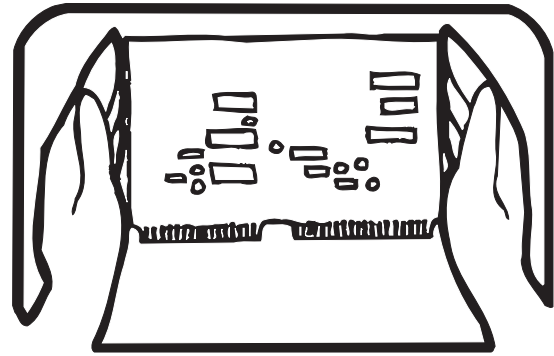

8. WHEN REMOVING PLUG-IN ASSEMBLIES HANDLE ONLY BY NON-CONDUCTIVE EDGES AND NEVER TOUCH OPEN EDGE CONNECTOR EXCEPT AT STATIC-FREE WORK STATION. PLACING SHORTING STRIPS ON EDGE CONNECTOR HELPS PROTECT INSTALLED S.S. DEVICES.

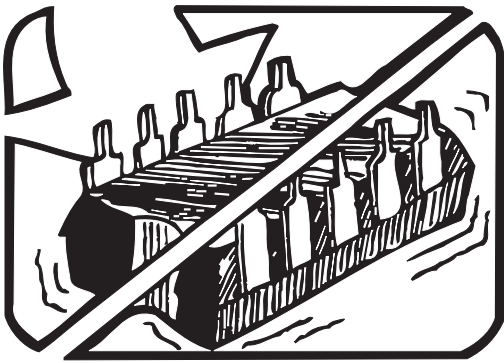

6. DO NOT SLIDE S.S. DEVICES OVER ANY SURFACE.

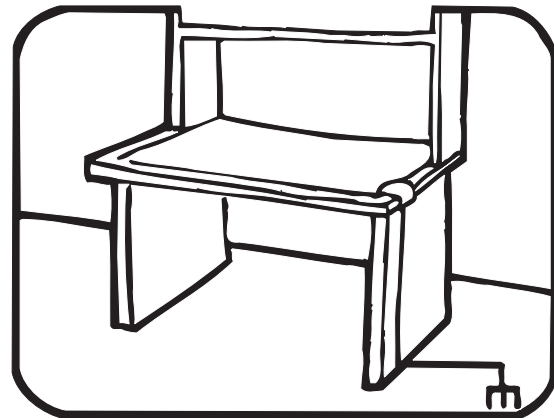

9. HANDLE S.S. DEVICES ONLY AT A STATIC-FREE WORK STATION.

10. ONLY ANTI-STATIC TYPE SOLDER-SUCKERS SHOULD BE USED.

11. ONLY GROUNDED-TIP SOLDERING IRONS SHOULD BE USED.

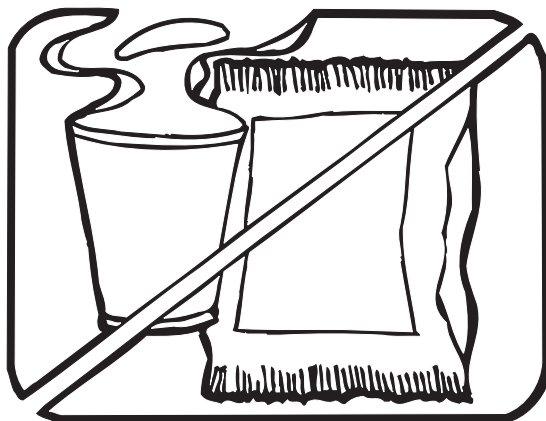

7. AVOID PLASTIC, VINYL AND STYROFOAM® IN WORK AREA.

PORTIONS REPRINTED  
WITH PERMISSION FROM TEKTRONIX INC.  
AND GERNER DYNAMICS, POMONA DIV.



## Testing the Fuse

### ⚠ ⚠ Warning

To avoid electrical shock or injury, remove the test leads and any input signals from the Meter before replacing the fuse.

Test the fuse as described below and illustrated in Figure 1. If the fuse is defective, see *Replacing the Batteries and/or Fuse* later in this manual.

1. Insert a test probe in the  $V \Omega \mu A$  input terminal.
2. Turn the rotary switch to  $\Omega$  and verify the Meter is in Auto Range.
3. Insert the probe in the mA input terminal. If the display reading is  $OL$ , the fuse is defective; replace the fuse.

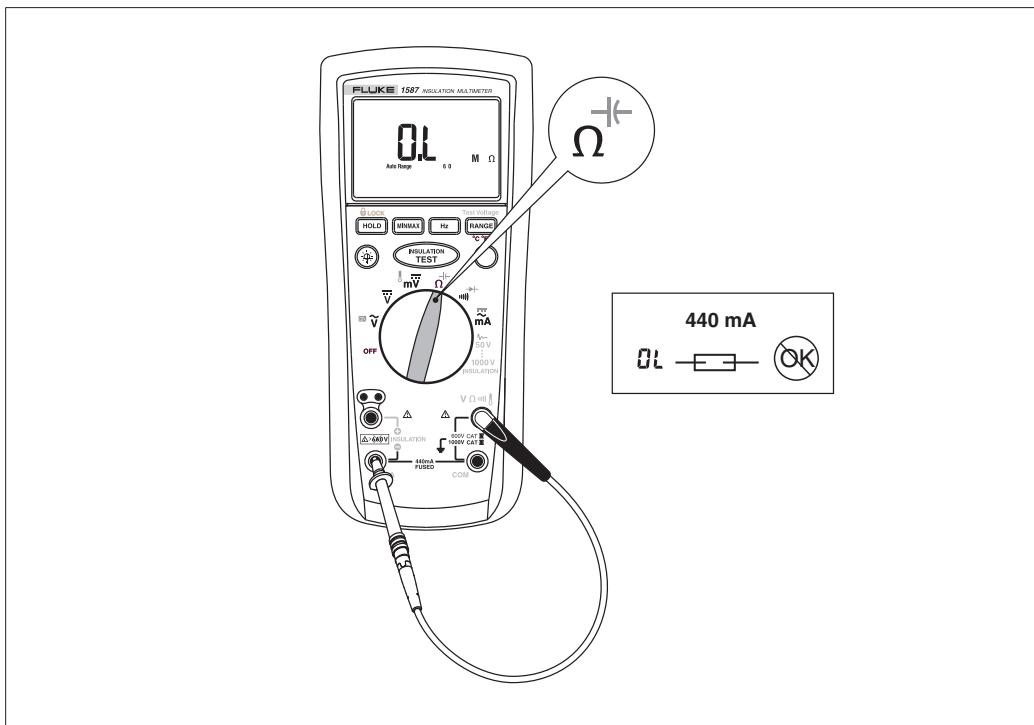

Figure 1. Testing the Fuse

ebp01f.eps

### Replacing the Batteries and/or Fuse

Use the following procedure and Figure 2 to replace the batteries and/or the fuse:

#### ⚠ ⚠ Warning

To avoid electrical shock, personal injury, or damage to the Meter observe the following warnings:

- Replace the batteries as soon as the battery indicator (🔋) appears. A weak battery can cause false reading.
  - Use ONLY fuses with the amperage, interrupt, voltage, and speed ratings specified.
  - Before removing the battery cover, turn the rotary switch to OFF, and then, remove the test leads from the front-panel terminals.
1. Remove the yellow rubber boot from the Meter. Use the thumb-hole to press on the rear of the Meter and peel the boot from the Meter.
  2. Using a standard screwdriver, release the battery door from the Meter; turn the battery-door lock until the unlock symbol aligns with the arrow.
  3. Lift the bottom of the battery door away from the Meter to access the fuse and battery compartment.
  4. Remove and replace the batteries and/or fuse as shown in Figure 2.
  5. Re-install the battery door and secure it by turning the battery door lock until the lock symbol (🔒) aligns with the arrow.
  6. Position the bottom of the Meter in the bottom of the boot, and press the top of the instrument firmly into of the boot.

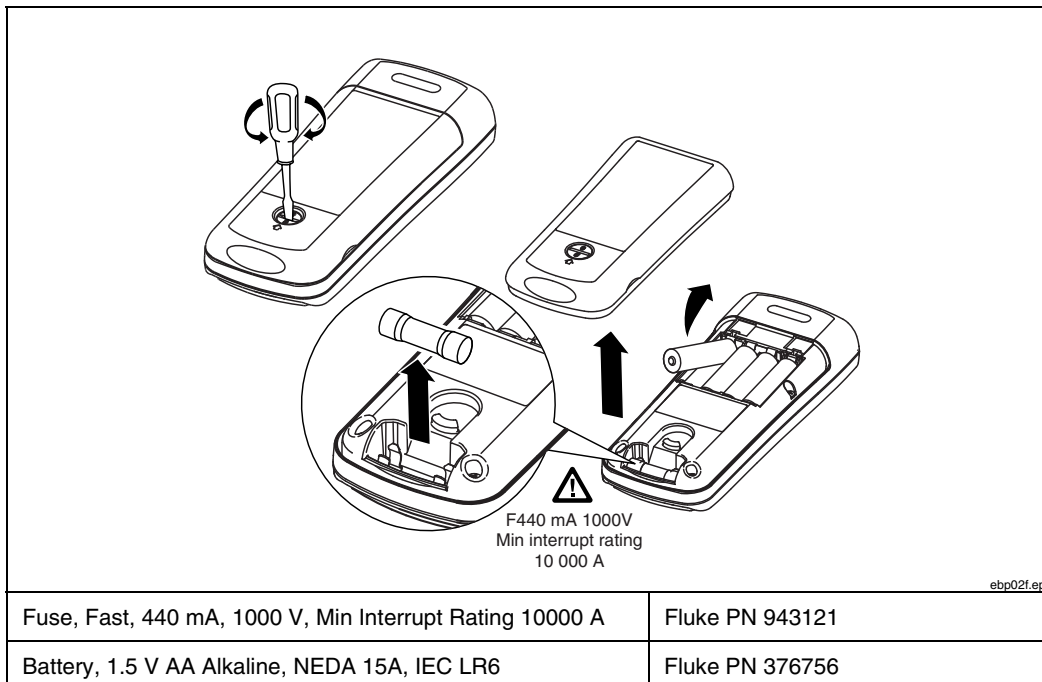

Figure 2. Replacing the Batteries and Fuse

### Testing the Display

The display is an LCD comprised of a series of characters and segments for providing the user with a variety of information. To test the LCD and all of its segments proceed as follows:

1. Set the rotary switch to **OFF**.
2. Depress **HOLD** and turn the function switch to  $\tilde{V}$ .
3. While continuing to depress **HOLD**, verify that the lit display segments match those shown in Figure 3.

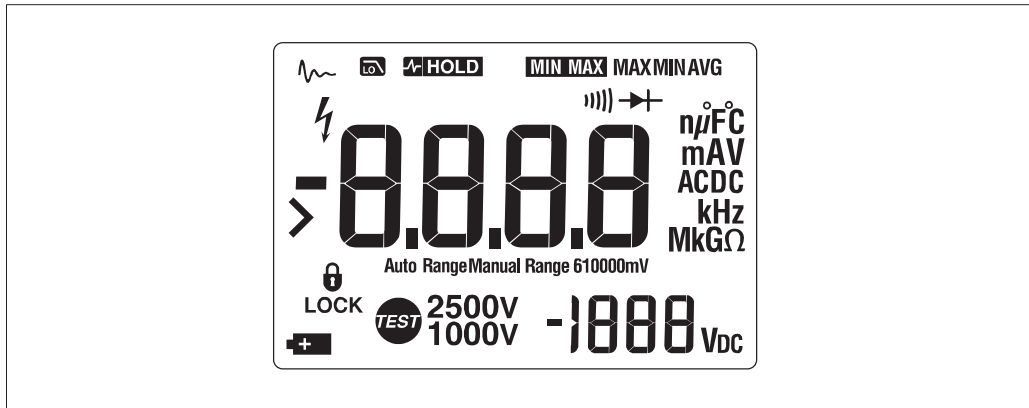

Figure 3. LCD Display Test

bav011.eps

### Testing the Backlight

The display backlight is a toggle function controlled by the  $\odot$  key. Each press of  $\odot$  causes the backlight to change states, i.e., on to off or off to on. To test the backlight, press  $\odot$  twice to verify that the toggle function is working. Turn the backlight off.

### Testing the Keypad

The keypad consists of the seven keys located above the rotary function switch. To test the keypad, turn the rotary switch to  $\tilde{V}$  and momentarily press each of the seven keys. Each press of an operational key will cause the Meter to beep. No beep in response to a key press indicates a defective keypad.

Reset the Meter by turning the rotary switch to OFF and, then, to any other position.

## Disassembling and Reassembling the Meter

This section of the manual provides instructions for disassembling and reassembling the Meter. The instructions are limited to major replaceable assemblies and do not include component-level detail. See Figure 4 for an exploded view of the major assemblies. Also, the emphasis is placed on disassembly. However, when appropriate, an italicized entry at the end of each disassembly procedure provides critical hints for reassembly.

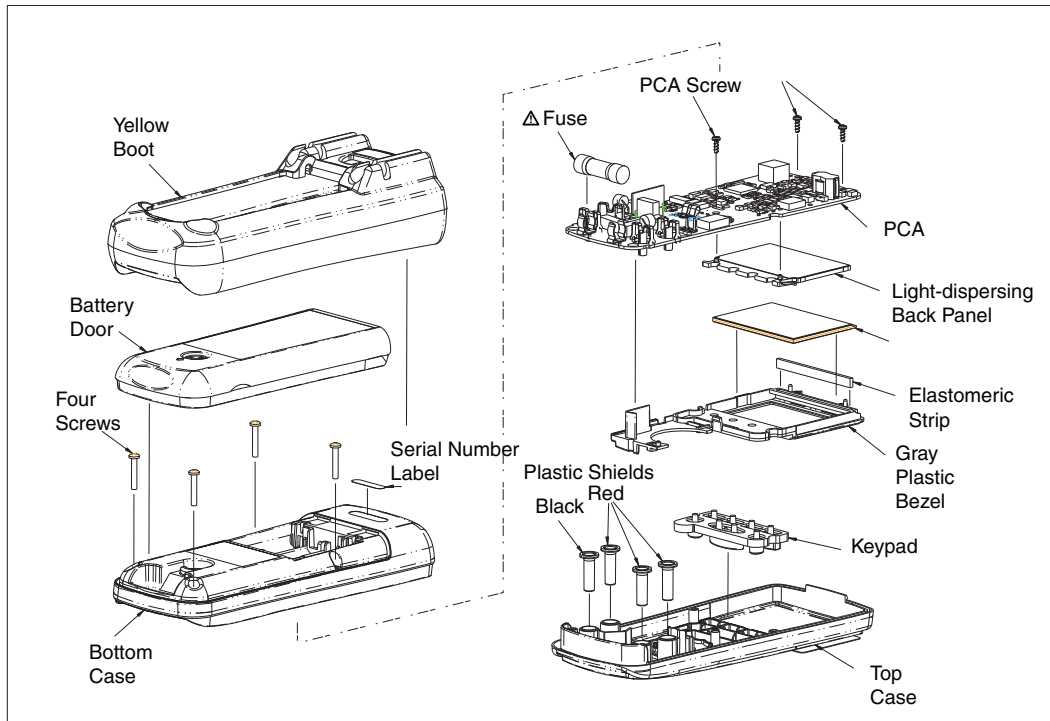

Figure 4. Disassembling the Meter

ebp04f.eps

### **Removing the Boot**

The standard Meter comes equipped with a snug-fitting yellow rubber boot. The boot helps protect the Meter from rough handling and is normally left on the Meter. The first step in disassembling the Meter is to remove the boot.

Use the following procedure to remove the boot:

1. Looking at the front of the Meter, place your thumbs on the top corners of the boot and firmly grasp the Meter.
2. Using both thumbs, push the boot up and over both corners of the Meter.
3. Continue pushing on the boot until both of its inside corners are resting on top of the Meter.
4. Now, rest the heel of one hand behind the display, and place all four fingers of the same hand along the upper front edge of the boot.
5. Firmly grasp the Meter with the other hand, and using your fingers, peel the boot over the top of the Meter.
6. Slide the Meter up and out of the boot.

*When installing the boot, position the bottom of the Meter in the bottom of the boot, and press the top of the instrument firmly into of the boot.*

### **Removing the Battery Door**

#### **⚠ ⚠ Warning**

**To avoid the risk of electrical shock, turn the rotary switch to OFF, and remove the test leads from the front-panel terminals before removing the battery cover.**

With the boot removed, the next step in disassembling the Meter is to remove the battery door. Use the following procedure to remove the door:

1. Locate the black slotted lock on the lower rear of the Meter.
2. Using a standard screwdriver, turn the battery-door lock until the unlock symbol (🔓) aligns with the arrow. The door is now unlocked.
3. Lift the bottom of the battery door away from the Meter. Removing the battery door provides access to the fuse and battery compartment.
4. If necessary, remove and replace the batteries and/or fuse as shown in Figure 2.

*When installing the battery door, first, slide the top of the door into position, and then, secure it by turning the battery door lock until the lock symbol (🔒) aligns with the arrow.*

### Removing the Bottom Case

With the battery door removed, the next step in disassembling the Meter is to remove the bottom case. Use the following procedure to remove the bottom case:

#### Note

*When removing the back case, it is not necessary to remove the fuse or the batteries.*

1. Locate the four Phillips head screws on the bottom case, two next to the batteries and two next to the fuse.
2. Using a Phillips screwdriver, remove the four screws.
3. Separate the front and bottom cases at the fuse-end of the Meter. Tilt the freed end of the case up, and lift it away from the top case.

*To install the bottom case, first, position and press together the display-end of the top and bottom cases. Then, prior to installing all four screws, press the fuse-end of the cases together.*

### Removing the PCA

With the bottom case removed, the next step in disassembling the Meter is to remove the printed circuit assembly (PCA). Refer to Figure 4 and use the following procedure to remove the PCA:

1. One Phillips screw attaches the PCA to the top case. Locate the screw near the center of the PCA, and remove it.
2. Two chrome-plated springs on the PCA form an electrical connection (clip) to the two recessed INSULATION(+) terminals on the top case. Break these connections by carefully pulling each of the springs back and away from the terminals. See Figure 5.
3. With one hand over the PCA, roll the top case over (face up) and lift it away from the PCA.

#### Note

*Three red and one black plastic shields are used to isolate the user from the input terminals. With the PCA removed, these shields are loose and can fall away from the PCA.*

4. Remove and set aside all four shields for use during reassembly.

### **⚠ ⚠ Warning**

**To avoid risk of electrical shock, make sure the plastic input terminals are properly positioned on the PCA before attaching it to the top case.**

*When installing the PCA, proceed as follows:*

1. *With the PCA face-up, place all four plastic shields into position on the PCA.*
2. *Lower the top case onto the PCA, and roll both parts over (PCA up).*
3. *Connect (snap) the chrome-plated springs to the INSULATION terminals.*
4. *Install the screw that attaches the PCA to the top case.*

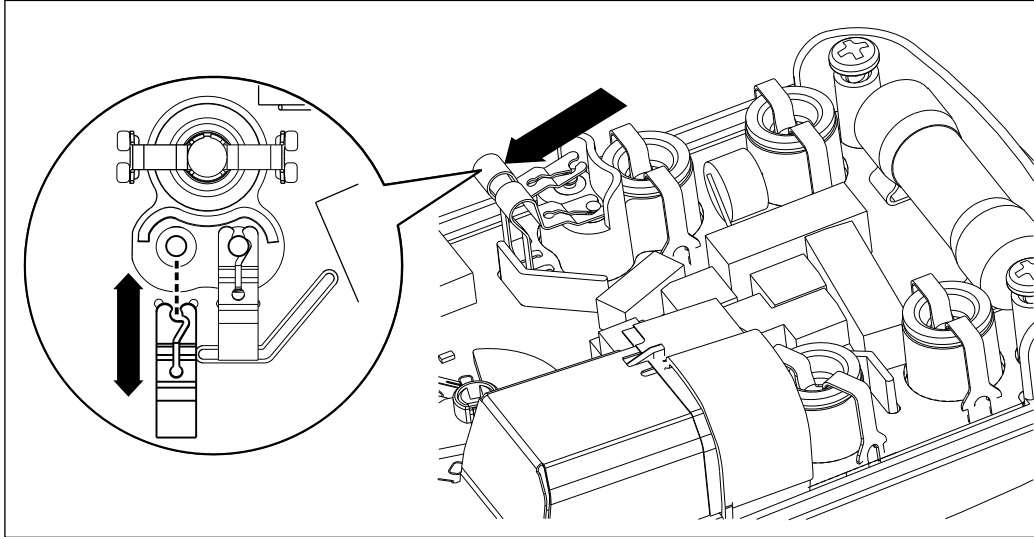

Figure 5. Insulation Terminal Clips

ebp11f.eps

### Removing the LCD

With the PCA removed, the final step in disassembling the Meter is to remove the LCD assembly from the PCA. Refer to Figure 6 and use the following procedure to remove the LCD assembly:

1. Remove the two screws from the display end of the PCA.
2. Hold the PCA face down with the fuse-end of the PCA toward you. Locate the screw-hole near the center of the assembly. This hole is the one used to attach (with a screw) the PCA to the top case.
3. Now, locate the gray plastic tab just above and to the left of the hole. Using your thumbnail press the tab down and toward the display end of the PCA. This will release the LCD assembly from the PCA.

#### **⚠ Caution**

**To avoid damaging the plastic guide pins on the LCD assembly, keep the LCD assembly parallel to the PCA when separating the two parts.**

4. Without tilting the PCA, lift it straight up and away from the LCD assembly.
5. To keep loose parts from falling away from the LCD assembly, keep it face-down, and set it in a safe place.

### Replacing the LCD

The LCD assembly consists of four pieces as shown in Figure 6:

- Translucent light-dispersing back panel
- Flexible elastomeric conducting strip
- Plastic Bezel for housing the assembly's components
- Glass LCD display

With the LCD assembly removed from the PCA, use the following procedure to replace the LCD:

1. Lift the translucent light-dispersing back panel off of the plastic bezel.
2. Remove the elastomeric strip from its slot in the bezel.

3. Remove the old glass LCD display from the bezel.

*Note*

*Make sure the new LCD display is clean (free of lint and finger prints) before placing it in position in the bezel.*

4. Position the new glass LCD display in the bezel; the silver face should face the rear, and the stepped portion of the glass should be directly under the elastomeric slot on the bezel.
5. Drop the elastomeric strip into its slot on the bezel.
6. Position the translucent light-dispersing back panel over the silver side of the glass LCD display. Make sure the guide pins on the light dispersing back panel are facing up and that they are on the side opposite the elastomeric strip.
7. While holding the LCD assembly (face down) in one hand, position the PCA (fuse side up) over the bezel; match the guide holes in the PCA with the plastic guide pins on the bezel and the translucent light dispersing back panel. After the LCD assembly is in position, lock it in place by pressing (below the display) the bezel against the PCA; listen for the tab on the bezel to snap (lock) into position on the PCA.
8. Secure the PCA to the LCD assembly by installing the two screws that attach the PCA to the bezel. These screws also ensure contact between the glass LCD display, the elastomeric strip, and the PCA.

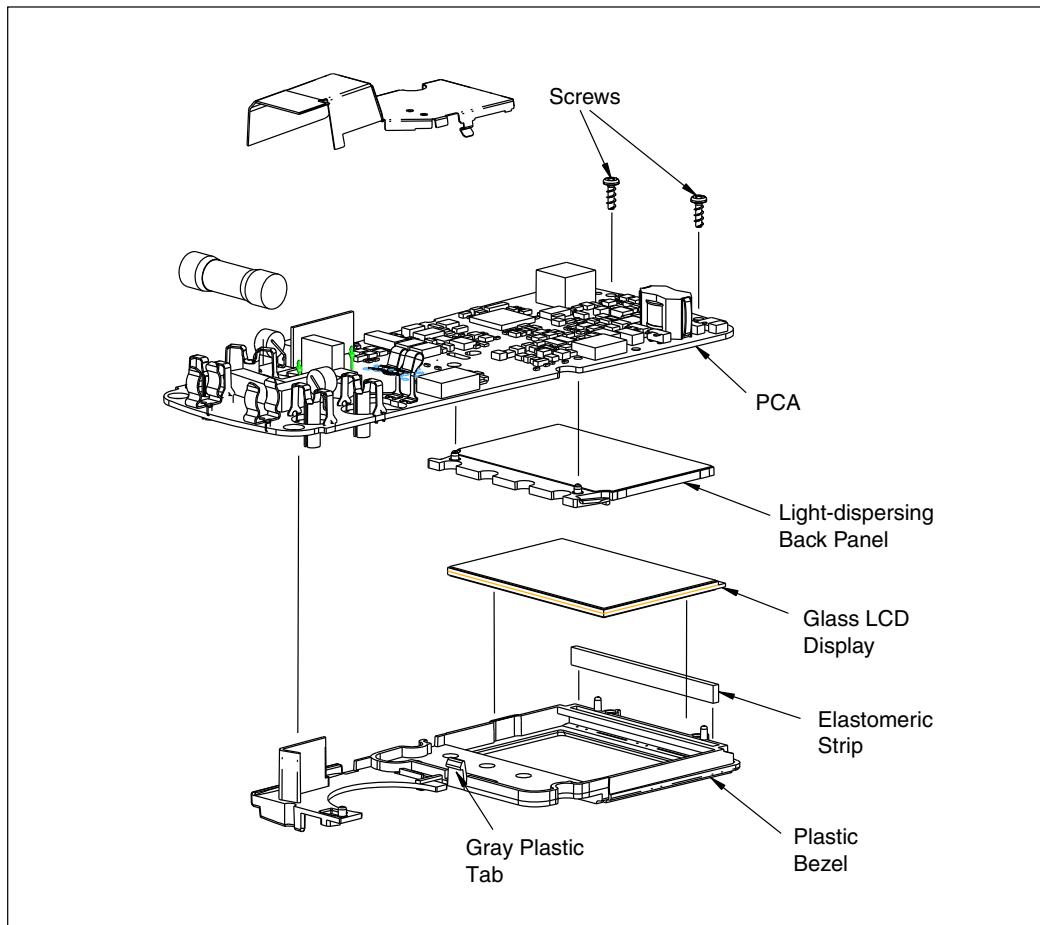

Figure 6. Accessing the LCD

ebp05f.eps



### Reassembling the Meter

To reassemble the Meter, logically reverse the previous disassembly procedures. In the process, make sure to re-establish all electrical connections; specifically, the elastomeric strip for the LCD, the red and black plastic shields for the input terminals, and the two spring contacts for the Insulation Test Probe. Also make sure all parts are correctly aligned and positioned; do not force-fit any of the parts into position.

### Required Tools and Equipment

Table 1 lists the required equipment for performing the Performance Test and Calibration adjustments. If a recommended model is not available, use a substitute with equivalent or better specifications.

**Table 2. Required Tools and Equipment**

Equipment	Required Characteristics	Recommended Model
Calibrator	<b>AC Voltage Range:</b> 0-1000V Accuracy: +/- 0.25% Frequency Range: 50Hz - 5 kHz Accuracy: +/-3% <b>DC Voltage:</b> 0-1000V Accuracy: +/-0.075% <b>Current Range:</b> 0-600 mA Accuracy: AC mA = +/-0.38% Frequency: 45Hz -1 kHz DC mA = +/-0.058% <b>Frequency Source:</b> 100Hz - 100 kHz Accuracy: +/-0.028% Amplitude: 5 Volt Accuracy: +/-5% <b>Ohms Range:</b> 0-50 MΩ Accuracy: +/-0.23% <b>Capacitance Range:</b> 700 nF - 8000 uF Accuracy: +/-0.35% <b>Insulation Resistance:</b> 500 kΩ - 1.7 GΩ Accuracy: +/-0.9%	Fluke 9100 w/135 option
DMM (Test DMM)	<b>DC Volts:</b> 0 to 1000V Accuracy: +/-5% <b>DC Current:</b> 0 - 2mA Accuracy: +/-1%	Fluke 189
Power Supply	<b>DC Volts:</b> 0 to 15V	Generic Lab Supply
HV Probe (Divider)	<b>DC Voltage Range:</b> 1kV -5 kV Accuracy: 1% <b>Division ratio:</b> 1000:1 <b>Input resistance:</b> 1000 MΩ	Fluke 80k-6
Thermocouple	K Type with Dual Banana connector	Fluke 80BK
Thermocouple Mini-Connector	K Type	Fluke 80CK-M

## Performance Test

The following series of tests comprise a performance test for verifying the accuracy of the Meter (UUT) and its performance level. The performance test is recommended as an acceptance test for incoming inspection and as a calibration procedure for periodically ensuring the accuracy of the Meter. Fluke recommends running the performance test at least once a year.

No adjustments are required during the performance test, and it is not necessary to open the case. If the Meter does not pass all parts of the performance tests, repair and/or calibration adjustment are required. A calibration adjustment procedure is given later in this manual. If significant repairs are required, contact Fluke as described toward the front of this manual. If user repairs are appropriate, refer to the list of user-replaceable parts toward the end of this manual



### Testing the 1577 and 1587 DMM Functions

Use the following procedure to verify the accuracy of the measurement functions.

1. Connect the Calibrator to the **V Ω** and **COM** input terminals on the UUT.
2. Turn the rotary switch to the function listed in each step of Table 2.
3. Apply the input level for each step listed in Table 2.
4. Compare the reading on the UUT display with the Display Reading in Table 2.

If the display reading falls outside of the range shown in Table 2, the UUT does not meet specification.

Table 3. DMM Accuracy Tests

Step	UUT Function	UUT Range	UUT Input Level	UUT Display Reading	
				Fluke 1577	Fluke 1587
1	mV ac	600.0 mV	30 mV, 60Hz	29.4 to 30.6	29.4 to 30.6
2	V ac	6.000V	3V, 60Hz	2.937 to 3.063	2.967 to 3.033
3	V ac	6.000V	3V, 400Hz	n/a	2.937 to 3.063
<b>Push  (blue) for 1 second for low-pass filter band-pass test</b>					
4	V ac	6.000V	3V, 400Hz	n/a	2.817 to 3.063
5	V ac	6.000V	3V, 800Hz	n/a	1.680 to 2.670
<b>Push  (blue) for 1 second to remove low-pass filter</b>					
6	V ac	60.00V	60V, 50Hz	58.77 to 61.23	59.37 to 60.63
7	V ac	600.0V	600V, 50Hz	587.7 to 612.3	593.7 to 606.3
8	V ac	1000V	1000V, 50 Hz	977 to 1023	n/a
9	V ac	1000V	1000V, 1 kHz,	n/a	977 to 1023
10	Hz, V ac	99.99 Hz	*10 Hz, 0.15V	n/a	9.98 to 10.02
11	Hz, V ac	99.99 kHz	*95kHz, 0.15V	n/a	94.89 to 95.11
12	Hz, V ac	99.99 kHz	*90 kHz, 2V	n/a	89.90 to 90.10
13	V dc	6.000V	0.3V	0.298 to 0.302	0.298 to 0.302
14	V dc	6.000V	6V	5.986 to 6.014	5.993 to 6.007
15	V dc	60.00V	60V	59.86 to 60.14	59.93 to 60.07

**Table 3. DMM Accuracy Tests (cont)**

Step	UUT Function	UUT Range	UUT Input Level	UUT Display Reading	
				Fluke 1577	Fluke 1587
16	V dc	600.0V	-600.0V	-601.4 to -598.6	-600.3 to -599.7
17	V dc	1000V	1000V	996 to 1004	997 to 1003
18	mV dc	600.0 mV	3 mV	2.9 to 3.1	2.9 to 3.1
19	mV dc	600.0 mV	30 mV	29.9 to 30.1	29.9 to 30.1
20	mV dc	600.0 mV	-600 mV	-601.3 to 598.7	-600.7 to -599.3
21	Ohms	600.0 Ω	0	-0.2 to 0.2	-0.2 to 0.2
22	Ohms	600.0 Ω	600 Ω	592.6 to 607.4	594.4 to 605.6
23	Ohms	6.000 kΩ	6000 Ω	5.926 to 6.074	5.944 to 6.056
24	Ohms	60.00 kΩ	60.00 kΩ	59.26 to 60.74	59.44 to 60.56
25	Ohms	600.0 kΩ	600.0 kΩ	592.6 to 607.4	594.4 to 605.6
26	Ohms	6.000 MΩ	6.000 MΩ	5.926 to 6.074	5.944 to 6.056
27	Ohms	50.00 MΩ	50.00 MΩ	48.97 to 51.03	49.22 to 50.78
28	Capacitance	1000 nF	700 nF	n/a	690 to 710
29	Capacitance	9999 uF	8000 uF	n/a	7814 to 8186
30	Continuity	n/a	103	Beeper off	Beeper off
31	Continuity	n/a	23	Beeper on	Beeper on
32	Diode	n/a	2.5 V	n/a	2.447 to 2.553
33	mA ac	60.00	3 mA, 45Hz	2.92 to 3.08	2.93 to 3.07
34	mA ac	600.0	400 mA, 60Hz	391.8 to 408.2	393.8 to 406.2
35	mA dc	60.00	60.00 mA	59.38 to 60.62	59.86 to 60.14
36	mA dc	600.0	400.0 mA DC	395.8 to 404.8	399 to 401

\* To ensure accurate frequency use the Calibrator Frequency mode.

### Testing Temperature Function (1587 Only)

Use the following procedure to verify that the UUT measures temperature within the published specification.

1. Connect the K-Type thermocouple to the temperature input of the UUT (V  $\Omega$   $\mu$   $\Omega$ ) and temperature calibrator.

#### Note

To ensure an accurate measurement the UUT and thermocouple connector must be at the same temperature.

2. After connecting the thermocouple to the UUT and the Calibrator, allow the junctions to stabilize before recording the display reading. Depending on temperature gradients this could take several minutes.
3. Turn the rotary switch to  $\frac{1}{mV}$ , and press  $\bigcirc$  to select temperature mode.
4. Put the calibrator in the thermocouple function, and set the output temperature to 23 °C.

The UUT display reading should be within the limits of 21.8 °C to 24.2 °C.

### Testing the Discharge Circuit

The following Discharge Circuit Test is a safety-related test that verifies input jack wiring to the PCA, the RSOB contacts, RSOB pads on the PCA, and other active discharge components on the PCA.

#### Caution

To prevent damage to the Test DMM DO NOT press  during the following procedure.

1. Connect the Test DMM to the **INSULATION** terminals (+ and -) on the UUT.
2. Set the Test DMM to measure resistance.
3. Turn the rotary switch to **INSULATION**.
4. Verify that the Test DMM reading is between 2500  $\Omega$  and 3500  $\Omega$ .

### Testing the Insulation Function

#### Warning

To avoid electric shock hazard at the **INSULATION** output terminals, do not press  when the rotary switch is set to **INSULATION**.

#### Caution

To prevent damage to the calibrator do not use the 5500A or other standard calibrators for the insulation tests.

#### Caution

To prevent damage to the 9100A make sure it is in the Insulation Test mode prior to pushing .

### Insulation Resistance Accuracy Test

To test the Insulation Resistance accuracy, sequentially complete the test steps in Table 4, using the following procedure.

1. Connect the **INSULATION** output terminals on the UUT to the calibrator.
2. Set the calibrator to the Insulation Resistance Test Mode.

3. Turn the rotary switch to **INSULATION**.
4. Set the voltage range on the UUT; see Table 4.
5. Apply the Calibrator Output to the UUT; see Table 4.
6. Press  on the UUT.
7. Verify that the display reading is within the limits given in Table 4.

**Table 4. Insulation Resistance Accuracy Test**

Step	UUT Voltage Range	Calibrator Resistance Range	Calibrator Output	UUT Display Reading	
				Limit Low	Limit High
1	500 V	60.0 MΩ	0.500 MΩ	0.0	1.0
2	500 V	500 MΩ	450 MΩ	438	462
3	500 V	500 MΩ	600 MΩ	>550	>550
4	1000 V	2.0 GΩ	1.7 GΩ	1.2	2.2
5	1000 V	600 MΩ	600 MΩ	586	614
<b>1587 Only</b>					
6	1000 V	60.0 MΩ	1 MΩ	0.5	1.5
7	50 V	6.00 MΩ	100 kΩ	0.05	0.15
8	50 V	50.0 MΩ	45 MΩ	43.1	46.9
9	100 V	6.00 MΩ	100 kΩ	0.05	0.15
10	100 V	100 MΩ	95 MΩ	87	103
11	250 V	60.0 MΩ	250 kΩ	0.0	0.8
12	250 V	250 MΩ	225 MΩ	217	233

**Insulation Function, External Sense**

The following test verifies that the UUT will sense a voltage > 30 V when present on the circuit under test.

1. Connect the UUT **INSULATION** output terminals to the calibrator voltage output terminals.
2. Turn the rotary switch to the **INSULATION** function.
3. Apply 35 V, 50 Hz to the UUT.
4. Verify that the UUT displays > 30 V in the primary display.

**Insulation Function, Source Voltage Accuracy Test**

The following test verifies the accuracy of the source voltage for the insulation function.

**⚠ Caution**

**To prevent damage to the Test DMM use a HV Probe (Divider) with the Test DMM when testing the 1000V range of the UUT.**

1. Connect the output of the HV Probe to the V – Com inputs on the Test DMM and turn the rotary switch to  $m\bar{V}$ .
2. Connect the input of HV Probe to the INSULATION output terminals on the UUT as shown in Figure 7.
3. Set the rotary switch to INSULATION.
4. Refer to Table 5, and complete steps 1 through 5. For each step, select the specified range on the UUT, press **INSULATION TEST**, and verify that the voltage readings on both the UUT (lower right hand corner) and the DMM are within the limits shown in the table.

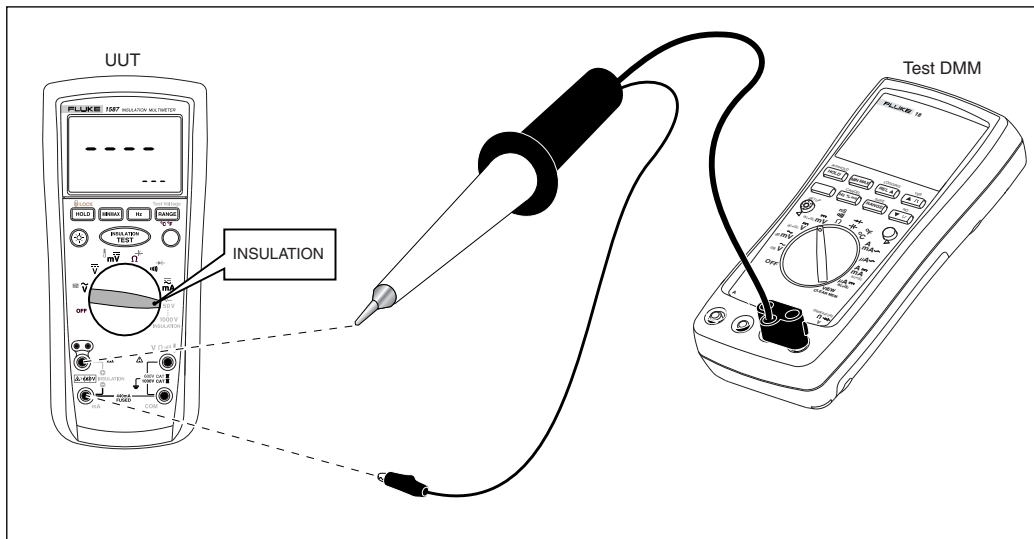

**Figure 7. Source Voltage Accuracy Test**

ebp06f.eps

**Table 5. Insulation Mode, Source Voltage Accuracy Tests**

Step	Function	Range	Test DMM Display Reading	UUT Display Reading
1	Insulation	500 V	500.0 to 600.0	500 to 600
2	Insulation	1000V	1000.0 to 1200.0	1000 to 1200
<b>1587 Only</b>				
3	Insulation	50V	50.0 to 60.0	50 to 60
4	Insulation	100V	100.0 to 120.0	100 to 120
5	Insulation	250V	250.0 to 300.0	250 to 300

### I Nominal Test

The following test verifies the ability of the UUT to maintain the nominal insulation test current while loaded.

1. Connect the Test DMM and Calibrator to the UUT INSULATION terminals as shown in Figure 8.
2. Set the Calibrator to the Insulation Resistance Test Mode.
3. Set the output resistance on the Calibrator 1 M  $\Omega$ .
4. Set the Test DMM to measure  $\mu\text{A}$  DC
5. Set the UUT to INSULATION, 1000V range.
6. Press **INSULATION TEST** on the UUT. The Test DMM reading should be greater than 1000.0  $\mu\text{A}$ .

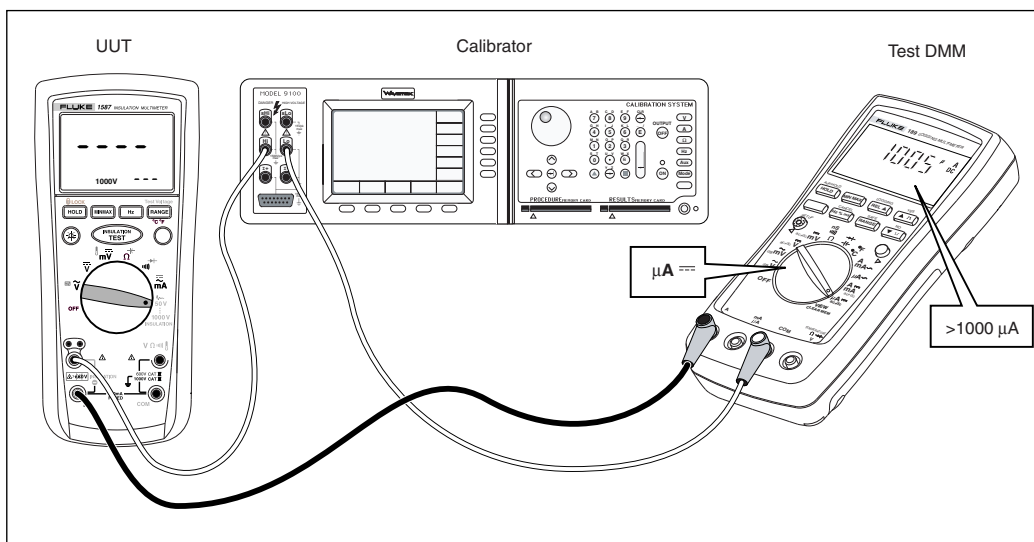

Figure 8. I Nominal Test

ebp071.eps

### Low-Battery Test - DMM Function

The following test verifies the accuracy of the low-battery indicator (**+**) on the UUT during DMM operations.

1. Remove the batteries from the battery compartment on the UUT.
2. Connect a 6-volt adjustable Power Supply between the positive and negative battery terminals of the UUT as shown in Figure 9.
3. Turn the rotary switch to  $\bar{v}$ .
4. Slowly reduce the Power Supply output while observing the display on the UUT. Verify that the low-batter indicator (**+**) appears when the voltage is at 4.0 V
5. Now slowly increase the Power Supply output while observing the display on the UUT. Verify that the low-battery indicator (**+**) on the UUT goes out at 4.4 V.
6. Slowly reduce the Power Supply output while observing the display on the UUT. Verify that the UUT displays **batt** at 3.5 V.
7. Turn the rotary switch to **OFF** to reset the display.

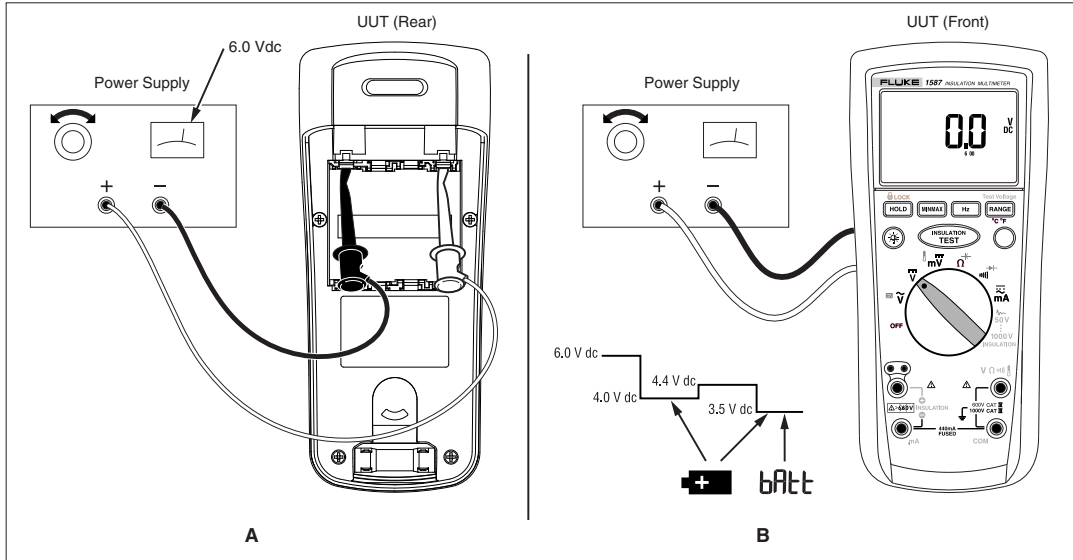



Figure 9. Low-Battery Test Connections

ebp08f.eps

### Low-Battery Test - INSULATION Function

The following procedure verifies the accuracy of the low-battery indicator (⊕) during insulation operation.

#### ⚠ ⚠ Warning

To avoid shock hazard DO NOT press  during the following procedure.

1. Remove the batteries from the battery compartment.
2. Connect a 6-volt adjustable Power Supply between the positive and negative battery terminals of the UUT as shown in Figure 9-A.
3. Set the Power Supply output to 6 V, and turn the rotary switch to **INSULATION**.
4. Slowly turn the Power Supply output down while observing the display on the UUT. Verify that the low-battery indicator (⊕) appears when the voltage is at 5.2 V.
5. Continue to reduce the Power Supply output while observing the display on the UUT. Verify that **bAtt** appears on the display when the supply voltage reaches 4.0 V.

#### Note

**bAtt** will appear in the lower display. **bAtT** will still appear in the primary display when the supply reaches 3.5 V just as it does in DMM functions.

6. Turn the rotary switch to **OFF** to reset the display.
7. Remove the Power Supply, and install the batteries and the battery door.



## Calibration Adjustment Procedure



The following sections comprise the Calibration Adjustment Procedure. The procedure is meant to bring the UUT back into specification following repair of the UUT or when the UUT fails the Performance Test. The required equipment is listed earlier in Table 2.

The Meter features closed-case calibration adjustment using known reference sources. During the procedures, known reference source values are applied to the meter; the Meter calculates correction factors and stores them in nonvolatile memory.

### Calibration Adjustment Counter

The Meter contains a calibration adjustment counter. The counter is incremented each time a Calibration Adjustment Procedure is completed. The value in the counter can be recorded and used to show that no adjustments have been made during a calibration cycle.

Use the following steps to view the calibration counter on the UUT.



1. While holding down  on the UUT, turn the rotary switch from **OFF** to  $\tilde{V}$ . The UUT should display  $\text{CAL}$ .
2. Press  once to see the calibration counter. For example  $n000$ .
3. Turn the rotary switch to **OFF**.

### Calibration Adjustment Password







To start the Calibration Adjustment Procedure, the correct four-digit password must be entered. The password can be changed or reset to the default as described in following paragraphs. The default password is  $1234$ .







### Changing the Password

Use the following steps to change the password on the UUT:

1. While holding down  on the UUT, turn the rotary switch from **OFF** to  $\tilde{V}$ . The UUT displays  $\text{CAL}$ .
2. Press  once to see the calibration counter.
3. Press  again to start the password entry. The UUT displays  $????$ .

The following keys represent the digit indicated below when entering or changing the password:

 = 1      Unused      Unused      = 2  
 = 3      = 4      = 5

4. Press the four keys to enter the old password. If changing the password for the first time, enter  (1),  (2),  (3), and  (4).
5. Press  to change the password. The UUT displays  $----$  if the old password is correct. If the password is not correct, the UUT emits a double beep, displays  $????$  and the password must be entered again. Repeat step 4.
6. Press the four keys representing the new password.
7. Press  to store the new password.

### Restoring the Default Password

If the calibration password is forgotten, the default password ( $1234$ ) can be restored using the following steps.

1. Turn the rotary switch from **OFF** to  $\tilde{V}$ .

2. Remove the back case from the UUT. Leave the PCA in the top case.
3. Apply 6.0 V across the battery pads (XBT1) + and – on the back of the PCA. See Figure 10.

**⚠ ⚠ Warning**

**To avoid electrical shock or personal injury, remove the test leads and any input signal before removing the back case from the UUT.**

4. Short across the **Cal** keypad on the back of the PCA. See Figure 10. The UUT should beep. The default password is now restored.
5. Remove the 6.0 V supply and install the back case on the UUT.

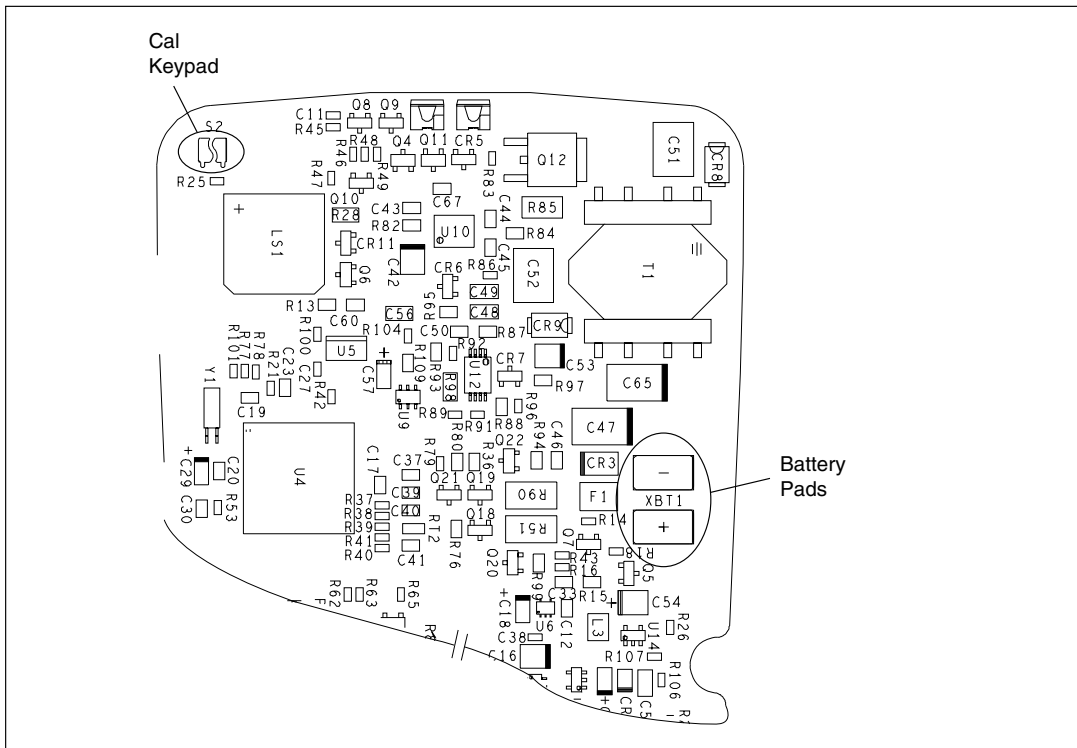





Figure 10. Restoring the Default Password

ebp10f.eps





### **Meter Keys Used in the Calibration Steps**

The Meter keys behave as follows when performing the Calibration Adjustment Procedure. This may be of help determining why a calibration step is not accepted and for determining the input value without referring to Table 6.

-  Press and hold to show the measured value. The measurement value is not calibrated so it may not match the input value. This is normal.
-  Press and hold to display the required input amplitude.
-  Press and hold to display the frequency of the required input.
-  Store the calibration value and advance to the next step. This key is also used to exit the calibration mode after the calibration-adjustment sequence is complete.

### **Calibration Adjustment**

Use the following steps to make calibration adjustments to the UUT. Complete the adjustment procedure before turning the UUT off; otherwise, the new calibration constants will not be saved.

1. While holding down , turn the rotary switch from **OFF** to  $\tilde{v}$ . The UUT displays  $\text{⚡} \text{CAL}$ .
2. Press  once to see the calibration counter, e.g.,  $n000$  |.
3. Press  again to start the password entry. The UUT displays  $????$ .
4. Press four keys to enter the password.
5. Press  to go to the first calibration step. The UUT displays  $[-0]$  if the password is correct. If the password is not correct, the UUT emits a double beep, displays  $????$  and the password must be entered again. Repeat step 4.
6. Using Table 6, apply the input value listed for each calibration adjustment step. For each step, position the rotary switch and apply the input to the terminals as indicated in the table.
7. After each input value is applied, press  to accept the value and proceed to the next step ( $[-02]$  and so forth).

*Note*

*After pressing , wait until the step number advances before changing the calibrator source or turning the rotary switch. If the rotary switch is not in the correct position, or if the measured value is not within the anticipated range of the input value, the UUT emits a double beep and will not continue to the next step. Some adjustment steps take longer to execute than others (10 to 15 seconds). For these steps, the UUT will beep when the step is complete. Not all steps have this feature.*

8. After the final step, the display shows **End** to indicate that the calibration adjustment is complete. Press  to go to meter mode.

*Note*

*Set the calibrator to Standby prior to changing the function switch position and/or after completing adjustment of each function. If the calibration adjustment procedure is not completed correctly, the UUT will not operate correctly.*

Table 6. Calibration Adjustment Steps

Switch Position (Function)	Input Terminal	Calibration Adjustment Step	Input Value	
AC Volts	V/COM	[-01]	600.0 mV, 60 Hz	
		[-02 (Model 1587 only) <sup>[1]</sup>	600.0 mV, 5 kHz	
		[-03]	6.000 V, 60 Hz	
		[-04 (Model 1587 only) <sup>[1]</sup>	6.000 V, 5 kHz	
		[-05]	60.00 V, 60 Hz	
		[-06 (Model 1587 only) <sup>[1]</sup>	60.0 V, 5 kHz	
		[-07]	600.0 V, 60 Hz	
		[-08 (Model 1587 only) <sup>[1]</sup>	600.0 V, 2 kHz	
DC Volts		[-09]	6.000 V, 0 Hz	
DC Millivolts		[-10]	60.00 V, 0 Hz	
		[-11]	600.0 V, 0 Hz	
Ohms		[-12]	600.0 mV, 0 Hz	
		[-13]	60.00 mV, 0 Hz	
		[-14]	600.0 Ω	
		[-15]	6.000 kΩ	
		[-16]	60.00 kΩ	
		[-17]	600.0 kΩ	
		[-18]	6.000 MΩ	
		[-19]	0.000 Ω	
Continuity		[-20]	50.0 MΩ	
Diode Test		[-21]	600.0 Ω	
milliamps		mA/COM	[-22 (Model 1587 only) <sup>[1]</sup>	6.000 V, 0 Hz
			[-23]	60.00 mA, 60 Hz
			[-24]	400.0 mA, 60 Hz
			[-25]	60.00 mA, 0 Hz
Insulation	mA/COM	[-26]	400.0 mA, 0 Hz	
		[-27]	1.0 mA, 0 Hz	
 <b>Warning</b> <b>To avoid electrical shock hazard, remove all test leads from the UUT before performing the following step.</b>				
Insulation	None <sup>[2]</sup>	[-28]	None (press BLUE to start internal cal)	
Notes:				
1. Calibration step will be skipped on Model 1577.				
2. Internal HV output calibration. Ensure no lead is inserted in Insulation (+) jack.				

## Service and Parts

User service is limited to replacing parts. Table 7 identifies the parts available for replacement and Figure 11 shows the location of each part. To order replacement parts refer to *Contacting Fluke* earlier in this manual.

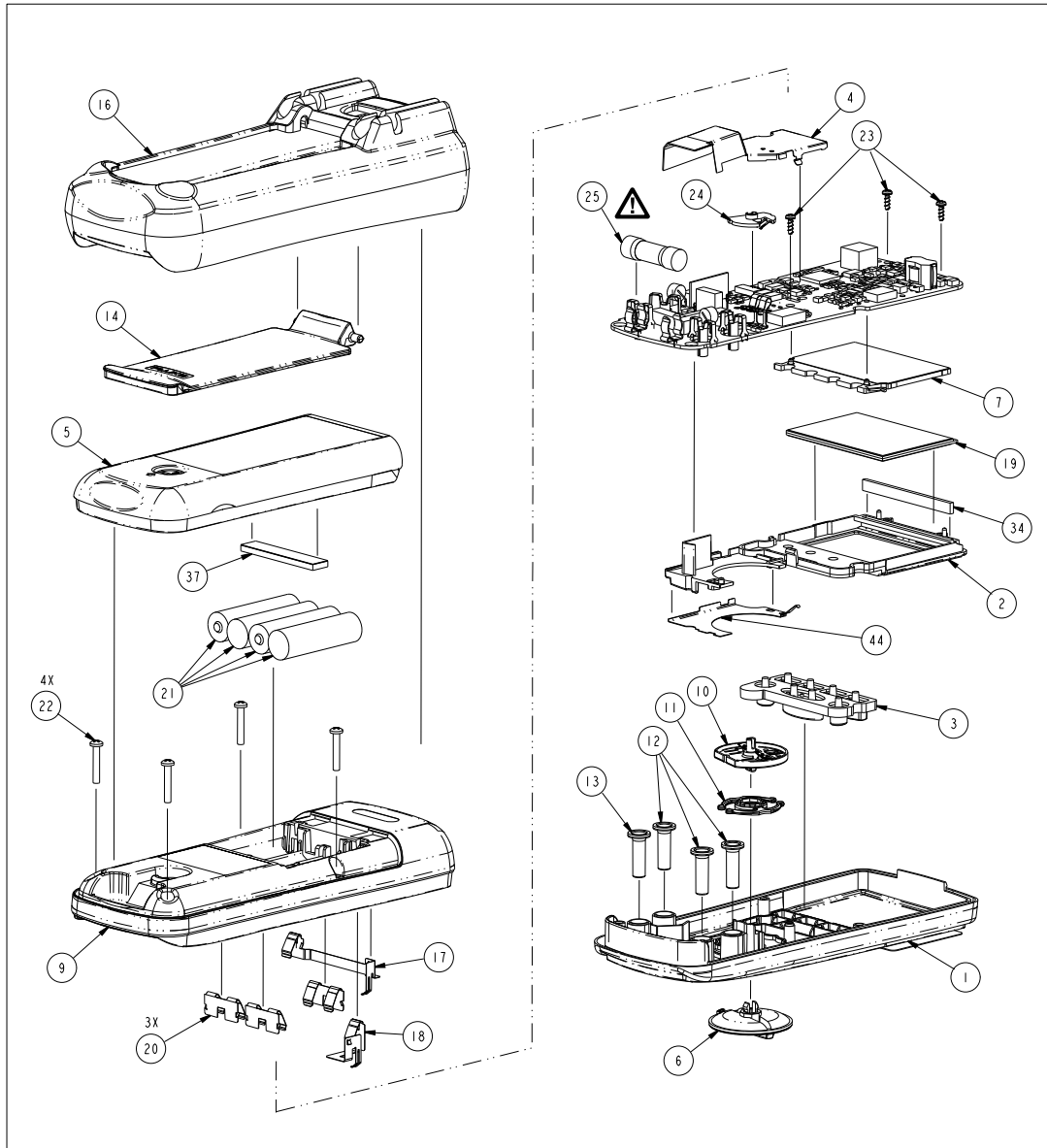

ebp09f.eps

Figure 11. 1587/1577 Replacement Parts

Table 7. 1587/1577 Replacement Parts

Item	P/N	Qty	Ref Des	Description
1	2277944	1	MP1	1577, Case Top
1	2277926	1	MP1	1587, Case Top
2	2277971	1	MP2	1577, Bracket, Mask
2	2277967	1	MP2	1587, Bracket, Mask
3	2281339	1	MP3	1577, Keypad
3	2281342	1	MP3	1587, Keypad
4	2277892	1	MP4	15x7, Shield, Bottom
5	2386438	1	MP5	1577, Door, Battery
5	2277998	1	MP5	1587, Door, Battery
6	2278007	1	MP6	15x7, Knob
7	2168609	1	MP7	15x7, Backlight
9	2277903	1	MP9	15x7, Bottom Case
10	2278018	1	MP10	15x7, Housing Assy, RSOB
11	2278029	1	MP11	15x7, Detent Spring
12	2278128	3	MP12-14	15x7, Insulator, Receptacle, Red
13	2278137	1	MP15	15x7, Insulator, Receptacle, Black
14	2278143	1	MP16	15x7, Tilt Stand
16	2278162	1	MP18	15x7, Holster
17	2281317	1	MP19	15x7, Battery Contact, Negative
18	2281321	1	MP20	15x7, Battery Contact, Pos
19	2141295	1	MP21	15x7, LCD, Display
20	666435	3	MP22-24	15x7, Battery Contact, Dual
21	376756	4	MP40-43	15x7, Battery, 1.5 V, 2.24 AH, 15 A, Alkaline, AA, 14X50 mm
22	832246	4	H26-29	15x7, Screw, 5-14, 0.750, Pan, Phillips, Blk, Thread Forming
23	642931	3	H30-32	15x7 Screw, 4-14, 0.312, Pan, Phillips, Zinc, Thread Forming
24	822676	1	MP32	15x7, Contact, PTF
25	943121	1	△ F1	15x7, Fuse, 0.406X1.375 Inches, 0.440A, 1000V, Fast
26*	2070140	1	MP26	15x7, TL224 Test Leads RA2S
27*	1273113	1	MP25	15x7, Thermocouple Assembly, Type K, 3 feet
28*	2000757	1	MP28	15x7, Probe, Multifunction
30*	2099044	1	MP30	15x7, Probe, Test, Banana Jack, 4mm Tip, Red
31*	2427138	1	MP31	15x7, Probe, Test, Banana Jack, 4mm Tip, Black
32*	1958646	1	MP47	15x7, Alligator Clip, Ex-Large Blk, IEC1010
33*	1958654	1	MP33	15x7, Alligator Clip, Ex-Large Red, IEC1010
34	2396462	1	MP34	15x7, Connector, Elastomeric
37	2401066	1	MP37	15x7, Absorber, Shock
41*	2416504	1	MP51	15x7, Hard Case, Molded
43*	1942029	1	MP53	15x7, Probe Cap, Gs-38 Red
44	2416177	1	MP54	15x7, Shield, Top
45*	2401027	1	MP55	15x7 Manual, Users
46*	2456783	1	MP56	15x7 Manual. Calibration
47*	2401011	1	MP57	15x7, CD, Manual Set
* Not Shown				